

Hypertherm[®]

HyPrecision Predictive™ Waterjet Pumps

P-15 / P-30 / P-50 / P-50S / P-60S / P-75S



Operator Manual

810120 | Revision 0 | English

HyPrecision, Seal Maintenance Indicator, SMI, Seal Maintenance Technology, SMT, AccuStream, Blue Goop, PURE Goop, and Hypertherm are trademarks of Hypertherm, Inc. and may be registered in the United States and other countries. All other trademarks are the property of their respective holders.

One of Hypertherm's long-standing core values is a focus on minimizing our impact on the environment. Doing so is critical to our, and our customers', success. We are always striving to become better environmental stewards; it is a process we care deeply about.

© 2018 Hypertherm, Inc.

HyPrecision Predictive™ Waterjet Pumps

P-15 / P-30 / P-50 / P-50S / P-60S / P-75S

Operator Manual

810120
Revision 0

English
Original Instructions

October 2018

Hypertherm Inc.

Etna Road, P.O. Box 5010
Hanover, NH 03755 USA
603-643-3441 Tel (Main Office)
603-643-5352 Fax (All Departments)
info@hypertherm.com (Main Office Email)

800-643-9878 Tel (Technical Service)

technical.service@hypertherm.com (Technical Service Email)

800-737-2978 Tel (Customer Service)

customer.service@hypertherm.com (Customer Service Email)

866-643-7711 Tel (Return Materials Authorization)**877-371-2876 Fax (Return Materials Authorization)**

return.materials@hypertherm.com (RMA email)

Hypertherm México, S.A. de C.V.

Avenida Toluca No. 444, Anexo 1,
Colonia Olivar de los Padres
Delegación Álvaro Obregón
México, D.F. C.P. 01780
52 55 5681 8109 Tel
52 55 5683 2127 Fax
Soporte.Tecnico@hypertherm.com (Technical Service Email)

Hypertherm Plasmatechnik GmbH

Sophie-Scholl-Platz 5
63452 Hanau
Germany
00 800 33 24 97 37 Tel
00 800 49 73 73 29 Fax

31 (0) 165 596900 Tel (Technical Service)**00 800 4973 7843 Tel (Technical Service)**

technicalservice.emea@hypertherm.com (Technical Service Email)

Hypertherm (Singapore) Pte Ltd.

82 Genting Lane
Media Centre
Annexe Block #A01-01
Singapore 349567, Republic of Singapore
65 6841 2489 Tel
65 6841 2490 Fax
Marketing.asia@hypertherm.com (Marketing Email)
TechSupportAPAC@hypertherm.com (Technical Service Email)

Hypertherm Japan Ltd.

Level 9, Edobori Center Building
2-1-1 Edobori, Nishi-ku
Osaka 550-0002 Japan
81 6 6225 1183 Tel
81 6 6225 1184 Fax
HTJapan.info@hypertherm.com (Main Office Email)
TechSupportAPAC@hypertherm.com (Technical Service Email)

Hypertherm Europe B.V.

Vaartveld 9, 4704 SE
Roosendaal, Nederland
31 165 596907 Tel
31 165 596901 Fax
31 165 596908 Tel (Marketing)
31 (0) 165 596900 Tel (Technical Service)
00 800 4973 7843 Tel (Technical Service)
technicalservice.emea@hypertherm.com
(Technical Service Email)

Hypertherm (Shanghai) Trading Co., Ltd.

B301, 495 ShangZhong Road
Shanghai, 200231
PR China
86-21-80231122 Tel
86-21-80231120 Fax
86-21-80231128 Tel (Technical Service)
techsupport.china@hypertherm.com
(Technical Service Email)

South America & Central America: Hypertherm Brasil Ltda.

Rua Bras Cubas, 231 – Jardim Maia
Guarulhos, SP – Brasil
CEP 07115-030
55 11 2409 2636 Tel
tecnico.sa@hypertherm.com (Technical Service Email)

Hypertherm Korea Branch

#3904. APEC-ro 17. Heaundae-gu. Busan.
Korea 48060
82 (0)51 747 0358 Tel
82 (0)51 701 0358 Fax
Marketing.korea@hypertherm.com (Marketing Email)
TechSupportAPAC@hypertherm.com
(Technical Service Email)

Hypertherm Pty Limited

GPO Box 4836
Sydney NSW 2001, Australia
61 (0) 437 606 995 Tel
61 7 3219 9010 Fax
au.sales@Hypertherm.com (Main Office Email)
TechSupportAPAC@hypertherm.com
(Technical Service Email)

Hypertherm (India) Thermal Cutting Pvt. Ltd

A-18 / B-1 Extension,
Mohan Co-Operative Industrial Estate,
Mathura Road, New Delhi 110044, India
91-11-40521201/ 2/ 3 Tel
91-11 40521204 Fax
HTIndia.info@hypertherm.com (Main Office Email)
TechSupportAPAC@hypertherm.com
(Technical Service Email)

Hypertherm products are designed and manufactured with a commitment to continuous quality control and safety. Contact a Hypertherm Technical Service Associate for information and support regarding the installation, operation, maintenance, and repair of this equipment.

Pump information 11

Warranty SC-13

Waterjet product warranty SC-13

Disclaimer SC-14

Product stewardship SC-15

National and local safety regulations SC-15

Certification test marks SC-15

Declaration of conformity SC-16

Differences in national standards SC-17

Higher-level systems SC-17

Environmental stewardship SC-19

Hypertherm products: waste and recycling SC-19

Chemical handling and usage SC-19

Particle emission and waste water quality SC-19

Safety SC-21

User qualification and training SC-22

Emergency medical information and treatment SC-22

Symbols and marks SC-23

Information and symbols SC-23

Symbols and marks found on the equipment SC-24

Measurements SC-26

1 Terminology 27

2 Product description 35

Flow of water and hydraulic fluid 36

 Cooling loop 37

Pump exterior 39

Pump interior 46

3 Optional equipment 51

4 Operation 53

Safety 54

Do a preoperation inspection 56

- Turn on the utilities56
- Use the controls57
 - Operation panel57
 - Operator interface: Operation screens58
- Operate the pump remotely60
- Operate the pump locally61
 - Operate the pump65
- Stop the pump67
 - Emergency67
 - Typical67

5 Preventive maintenance 69

- Safety70
- Benefits of preventive maintenance71
- Training71
- Tools72
- Preventive maintenance schedule73
- General76
 - Examine and clean the equipment76
 - Examine the pump for leaks or damage78
- Electrical system79
 - Make sure that the emergency stop operates correctly79
 - Make sure that the electrical interlock operates correctly79
 - Examine cords, plugs, and cables80
- Hydraulic system81
 - Check the hydraulic filter81
 - Check the hydraulic fluid level82
 - Check the hydraulic fluid quality83
 - Lubricate the primary motor bearings87
- Low-pressure water system89
 - Examine the transport tubes89
 - Clean the Seal Maintenance Indicator tubes89
 - Replace the Seal Maintenance Indicator tubes91
 - Measure the air pressure in the water accumulator tank92
 - Check the low-pressure water pressure gauges93
 - Replace the water filters93
 - Test the low-pressure water TDS level95
- High-pressure water system: Intensifier97
 - Prepare to do maintenance on the intensifier98
 - Disassemble the intensifier99

Assemble the intensifier	108
High-pressure water system: Bleed-down valve	122
Remove the bleed-down valve from the pump	122
Disassemble the bleed-down valve	123
Assemble the bleed-down valve	124
Install the bleed-down valve	125
Start the pump after maintenance	126
Operator interface: Maintenance screens	127
Primary maintenance screen	128
Postmaintenance start procedure	132
Prepare for storage	135
Recycling and end of product life	136
6 Parts lists	137
Tools	138
Maintenance kits	139
Replacement parts	143
Electrical system	143
Hydraulic system	144
Low-pressure water system	145
High-pressure water system	147
Other parts	148
7 Troubleshooting	149
Safety	150
Normal status	152
Pump starting	152
Pump on	152
Alarms	152
Warnings	153
Faults	156
Intensifier problems	158
Intensifier control	158
Stroking	158
High-pressure water seal life is short	162
Hydraulic fluid	162
Temperature	162
Pressure	164
Level	164
Leaks	165
Water	166

Contents

- Pressure 166
- Leaks 168
- Seal Maintenance Indicator (SMI) 171
 - Operator interface 172
- A warning or a fault occurs during the start sequence 174
- The pump makes noise during operation 174
- Controller problems 175
 - Input/output status 175

8 Pump specifications 177

- All HyPrecision pump models 178
 - Environmental conditions 178
 - Hydraulic fluid 178
 - Utilities 178
- HyPrecision P-15 180
- HyPrecision P-30 181
- HyPrecision P-50 182
- HyPrecision P-50S 183
- HyPrecision P-60S 184
- HyPrecision P-75S 185
- Orifices 186
- Torque values 187
 - Fasteners 187
 - Fittings 188

9 Installation 193

- Safety 194
- Buyer responsibilities 196
- Requirements 197
 - Location 197
 - Temperature 197
 - Hydraulic fluid 197
 - Utilities 198
- Receive and unpack the equipment 199
- Install the pump 200
 - Install the external heat exchanger (optional) 200
 - Install the external boost pump (optional) 202
 - Install the external plumbing package (optional) 204
 - Make the connections to the utility panel 205
 - Add hydraulic fluid 207

- Connect the electrical power 208
- Do the first start 209
 - Do a preoperation inspection 209
 - Turn on the utilities 209
 - Make sure that the primary motor turns in the correct direction 210
 - Make sure that the heat exchanger fan motor turns in the correct direction 212
 - Turn on the pump 213
 - Adjust the external boost pump pressure 213
 - Measure the air pressure in the water accumulator tank 214
 - Flush the pump and the high-pressure tubing 215
- Operator interface: Adjustment screens 216
 - Primary adjustments screen 217
- Remote operation 226
- Storage 226

- 10 Technical drawings 227**

Model

Serial number

The serial number is on the data plate, which is found on the utility panel on the back of the pump.

System schematic drawing number

The system schematic drawing number is found in the electrical enclosure door on a green label.

Purchase date

Distributor

Installation date

Installed by

Notes

Waterjet product warranty

Product	Warranty coverage up to
HyPrecision pump	27 months from the ship date, or 24 months from the date of proven installation, or 4,000 hours of operation, whichever occurs first
PowerDredge™ abrasive removal system	15 months from the ship date, or 12 months from the date of proven installation, whichever occurs first
EcoSift™ abrasive recycling system	15 months from the ship date, or 12 months from the date of proven installation, whichever occurs first
Reverse osmosis system	15 months from the ship date, or 12 months from the date of proven installation, whichever occurs first
Bulk abrasive pot	15 months from the ship date, or 12 months from the date of proven installation, whichever occurs first
Abrasive regulator	15 months from the ship date, or 12 months from the date of proven installation, whichever occurs first
On/off valve air actuator	15 months from the ship date, or 12 months from the date of proven installation, whichever occurs first
Diamond orifice	600 hours of operation with the use of a thimble filter and compliance with Hypertherm's water quality requirements

Hypertherm's warranty does not extend to defects, failures, damages, deficiencies, or errors that are:

- not reported to Hypertherm within the warranty period; or
- the result of modification, abuse, misuse, noncompliance with the installation or operation instructions, unauthorized repair, inadequate maintenance, neglect, accident, or the use of unapproved parts; or
- the result of normal wear; or
- the result of the system being operated contrary to Hypertherm's instructions or stated limits of rated and normal use.

For information about the manufacturer's warranty, refer to the conditions of sale provided when the product was purchased.

Consumable parts are not included in this warranty. Consumable parts include high-pressure water seals, check valves, cylinders, bleed-down valves, low-pressure seals, high-pressure tubing, and filters.

All third-party motors, pumps, and plumbing accessories are warrantied by the respective manufacturers and are not included in this warranty.

Disclaimer

All product information contained in this manual is believed to be reliable as of the date of publishing the manual. The content is subject to change without notice. Content in the manual could contain technical inaccuracies or typographical errors and could be changed or updated without notice.

Hypertherm maintains a global regulatory management system to make sure that products comply with regulatory and environmental requirements.

National and local safety regulations

National and local safety regulations shall take precedence over instructions supplied with the product. The product shall be imported, installed, operated, and discarded in compliance with national and local regulations applicable to the installation site.

Certification test marks

Certified products are identified by 1 or more certification test marks from accredited testing laboratories. The certification test marks are on or near the data plate.

Each certification test mark means that the product and its safety-critical parts conform to the national safety standards as reviewed and determined by that testing laboratory. Hypertherm puts a certification test mark on its products only after that product is manufactured with safety-critical parts that have been approved by the accredited testing laboratory.

Once the product has left the Hypertherm factory, the certification test marks are invalid if any of these events occurs:

- The product is modified in a manner that causes danger or does not conform with the applicable standards.
- Safety-critical parts are replaced with unapproved spare parts.
- Assembly is unauthorized.
- An accessory that uses or generates dangerous voltage is added.
- A safety circuit or other feature that is designed into the product as part of the certification has been tampered with.

The Conformité Européene (CE) mark affixed to a product signifies the manufacturer's declaration of conformity to applicable European directives and standards.

Only those versions of Hypertherm products with a CE mark on or near the data plate have been tested for compliance with the applicable European directives, such as the Low Voltage Directive, the Electromagnetic Compatibility Directive, and the Machinery Directive.

To see the Declaration of Conformity in English and other languages:

1. Go to www.hypertherm.com/docs.
2. Select **Waterjet Family** in the Product/Product type dropdown list.
3. Select **Regulatory** in the Category dropdown list.

The navigation instructions can change without notice.

Declaration of conformity



Hypertherm Waterjet
305 2nd St NW
New Brighton, MN 55112 USA
www.hypertherm.com

EC DECLARATION OF CONFORMITY

Declaration of conformity (LXX) applies to the following HyPrecision Waterjet Pump Models based on testing performed on models HyPrecision™ P-15 and HyPrecision™ P-50S:

HyPrecision P-15

HyPrecision P-50

HyPrecision P-60S

HyPrecision P-30

HyPrecision P-50S

HyPrecision P-75S

Date of first fixing of CE marking (DOC issued): 26-September-2018

Date of this DOC: 26 September 2018

The undersigned official of the company hereby declares, on behalf of Hypertherm Waterjet Business Team, that model units with CE Marking on the data plate meet the essential requirements of the following EU Directives:

2006/42/EC Machinery Directive

2014/30/EU Electromagnetic Compatibility Directive

Using the relevant section of the following EU standards and other normative documents:

2014/30/EU:

EN 55011:2009+A1:2010

EN 61000-4-2:2009

EN 61000-4-3:2006+A1:2008+A2:2010

EN 61000-4-4:2004+AC:2006+A1:2010

EN 61000-4-5:2006

EN 61000-4-6:2009

EN 61000-4-8:2010

EN 61000-4-11:2004

2006/42/EC

EN/IEC 60204-1:2006+A1:2009

ISO 12100:2010

EN 1829-1:2010

Sara Mancell, Business Team Leader – Waterjet

Note 1: The Technical Construction File including the test reports and other information required by these EU Directives is maintained at the above address.

Note 2: This DOC is not valid on units without CE Marking on the data plate.

Note 3: For European customer inquiries, contact Arne van der Boon, European Customer Service Hypertherm Europe B.V. Vaartveld 9 4704 SE, Roosendaal, The Netherlands Telephone +31(0)165 596907

Differences in national standards

Nations can apply different performance, safety, or other standards. National differences in standards include, but are not limited to:

- Voltage
- Plug and cord ratings
- Language requirements
- Electromagnetic compatibility requirements

Differences in national or other standards can make it impractical or impossible for all certification test marks to be put on the same version of a product. For example, the Canadian Standards Association (CSA) versions of Hypertherm's products do not comply with European electromagnetic compatibility requirements and therefore do not have a CE mark on the data plate.

Countries where the CE mark is necessary or that have compulsory electromagnetic compatibility regulations must use CE versions of Hypertherm products with the CE mark on the data plate. These could include:

- Countries in the European Union
- Australia
- New Zealand
- Russia

It is important that the product and its certification test mark be suitable for the end-use installation site. When Hypertherm products are shipped to one country for export to a different country, the product must be correctly configured and certified for the end-use installation site.

Higher-level systems

When an original equipment manufacturer (OEM) or a system integrator adds equipment such as cutting tables, motor drives, motion controllers, or robots to a Hypertherm waterjet cutting system, the system is considered a higher-level system. A higher-level system with dangerous moving parts can constitute industrial machinery or robotic equipment, in which case the OEM, system integrator, or end-use customer can be subject to more regulations and standards than those applicable to the waterjet cutting system manufactured by Hypertherm.

It is the responsibility of the end-use customer and the OEM or system integrator to do a risk assessment for the higher-level system and to provide protection against dangerous moving parts. Unless the higher-level system is certified when the OEM or system integrator incorporates Hypertherm products into it, the installation can be subject to approval by local authorities. Get advice from legal counsel and local regulatory experts if you are not sure about compliance.

External cables connecting parts of the higher-level system must be made for exposure to contamination and movement as necessary for the end-use installation site. When the external interconnecting cables are subject to exposure to oil, dust, water, or other contamination, hard usage ratings could be necessary. When external interconnecting cables are subject to continuous movement, constant flexing ratings can be necessary. It is the responsibility of the OEM, system integrator, or end-use customer to make sure that external connecting cables are correct for the application and obey all national, state, and local regulations.

Hypertherm products: waste and recycling

Hypertherm waterjet cutting systems, like all products with electronics, can contain materials or parts, such as printed circuit boards, that can not be discarded with ordinary waste. It is your responsibility to discard Hypertherm products or parts in an environmentally suitable manner and in compliance with national and local codes.

In the United States, read all national, state, and local laws. In the European Union (EU), read the EU directives, national, and local laws. In other countries, refer to national and local laws. Consult with legal or other compliance experts, when applicable. For information, go to www.hypertherm.com/customer-support/product-service/recycling.

Chemical handling and usage

Material safety data sheets (MSDS) and safety data sheets (SDS) are part of a hazard communication plan that supplies detailed information about dangerous chemicals. The information includes the chemical's toxicity and reactivity, first aid for exposure, approved storage and disposal, recommended protective equipment, and spill-handling procedures.

The Occupational Safety and Health Administration (OSHA) has presented new dangerous chemical labeling requirements as a part of its recent revision of the Hazard Communication Standard (29 CFR 1910.1200), to align with the United Nations' Globally Harmonized System of Classification and Labelling of Chemicals (GHS). The GHS is an international system for standardizing chemical classification and labeling.

Chemical regulations in the USA, Europe, and other locations require that MSDS and SDS be made available for chemicals that are supplied with the product and chemicals used in or on the product. The list of chemicals is supplied by Hypertherm.

To see MSDS and SDS:

1. Go to www.hypertherm.com/docs.
2. In the "Product/Product type" dropdown list, select **Waterjet Family**.
3. In the "Category" dropdown list, select **Material Safety Data Sheets**.

These navigation instructions can change without notice.

Particle emission and waste water quality

Hypertherm does not manufacture or supply the materials that are cut and has no knowledge whether the particles released from materials that are cut can pose a physical danger or health risk. Get advice from with your supplier or other technical advisor for guidance concerning the properties of the material you cut with a Hypertherm product.

If you are not fully aware of and up to date on all applicable government regulations and legal standards for the installation site, Get advice from a local expert before purchasing, installing, and operating the equipment.

The end user is responsible for the safe operation of this equipment.

 WARNING	Before operating Hypertherm equipment, read the safety instructions in your product's manual.
---	--

Copies of the manuals can accompany the product in electronic and printed formats. Copies of the manuals are online, in all languages available for each manual.

1. Go to www.hypertherm.com/docs.
2. In the “Product/Product type” dropdown list, select **Waterjet Family**.
3. In the “Category” dropdown list, select **Manuals/Service Information**.
4. In the “All subcategories” dropdown list, select **Operator Manual (OM)**.

These navigation instructions can change without notice.

The safety precautions in this manual are general and can not anticipate every situation. Hypertherm, Inc. acknowledges that unforeseen situations such as equipment failure, site variability, insufficient maintenance, failure of control equipment, and other events can cause equipment damage, injuries, or death. It is the user's responsibility to identify dangers and to take the steps necessary to minimize risks.

Keep these instructions near the equipment. This manual is intended to familiarize the user with the equipment and its parts, safe operation, and maintenance.

All personnel who operate or have access to this equipment must know this information:

- Applicable safety standards
- The use, limitations, and maintenance of personal protective equipment
- The location of the written hazard communication program and safety data sheets
- How to recognize dangerous energy sources
- The correct methods for isolating and controlling energy, to include lock out–tag out procedures

Safety

User qualification and training

All users must read and understand these instructions before installing, operating, or doing maintenance on this equipment.

Do not let an untrained person to operate this equipment. Operators must be approved to operate and maintain this equipment. Training should include this information:

- How to start and stop the equipment during operation and in an emergency situation
- Conditions and procedures that can lead to injuries to personnel and damage to the equipment
- How to operate all controls
- How to identify and respond to a problem with the equipment
- How to do maintenance procedures
- A copy of the operator manual

This list is not all-inclusive.

Emergency medical information and treatment

High-pressure equipment puts the operator and other personnel in the area at risk of contact with high-pressure water. Possible injuries could include eye damage, lacerations, infections, and amputations. Do not put ice or heat on a waterjet injury. Use a support to keep injured limbs and extremities above heart level, if possible.













Waterjet operators should have a waterproof emergency medical tag or card that describes high-pressure waterjet injuries and the recommended treatment. Show the tag or card to emergency responders and medical professionals.

This card can be copied, cut out, laminated, and folded.



 <p>MEDICAL INFORMATION</p> <p>A high-pressure injection injury is a surgical emergency.</p> <p>Get medical treatment immediately for all high-pressure waterjet injuries.</p>	<p>The person with this card has been exposed to a waterjet of up to 4,140 bar (60,000 psi) and a velocity of 609 m/s (2,000 feet/second). The waterjet can contain abrasive materials.</p> <p>Skin can appear to be not damaged or show a small pinhole-sized puncture wound. The injured area can become swollen, painful, and pale over the next 4 to 6 hours. Tissue becomes ischemic and necrotic within 12 hours.</p> <p>Consult a surgical specialist immediately for decompression, removal of foreign materials, and debridement.</p> <p>Give broad-spectrum, intravenous antibiotics for Gram-negative and Gram-positive organisms.</p> <p>X-ray is the preferred imaging method.</p> <p>Acute compartment syndrome is possible.</p> <p>Leave the wound open.</p>	<p>Do not use solvents other than isotonic sodium chloride solution for irrigating the wound.</p> <p>Do not use digital or local nerve blocks.</p> <p>Give analgesics by mouth or injection.</p>
--	--	--

Information and symbols

Some symbols in this table could apply to other products.













 DANGER	<p>This symbol identifies an imminently dangerous condition or a situation that will cause serious injuries or death if ignored.</p>
 DANGER	<p>DANGEROUS VOLTAGE/RISK OF SHOCK</p>
 DANGER	<p>A waterjet is a cutting tool. Keep away from high-pressure streams and leaks. Pressurized fluid can cause injuries. A high-pressure injection injury is a surgical emergency. Get medical treatment immediately for all high-pressure waterjet injuries. Delayed treatment can cause injuries or death. Abrasive waterjets eject a mixture of water and abrasive materials that can be injected into body tissues, leading to a dangerous infection.</p>
 WARNING	<p>This symbol identifies a possibly dangerous condition or a situation that could cause injuries or death if ignored.</p>
 CAUTION	<p>This symbol identifies a possibly dangerous condition or a situation that could cause minor or moderate injuries or will cause damage to the equipment if ignored.</p>
	<p>This symbol identifies a condition or a situation that could cause damage to the equipment if ignored.</p>
	<p>Wear approved eye protection when operating or doing work near this equipment.</p>
	<p>Wear approved ear protection and control exposure time when operating or doing work near this equipment.</p>
	<p>Wear approved hand protection when operating or doing work near this equipment.</p>
	<p>Wear approved respiratory protection when operating or doing work near this equipment.</p>
	<p>This symbol identifies a mandatory action.</p>
	<p>This symbol identifies a prohibited action.</p>
	<p>Refer to the instruction manual. Read and understand all of the safety guidelines in this manual.</p>











Symbols and marks

	This symbol identifies tools or materials that are necessary or recommended for a procedure.
	This symbol identifies information that could cause the user to fail at the task if ignored.
	This symbol identifies a tip or helpful information.





Symbols and marks found on the equipment

Some symbols or marks in this table could apply to other products.

  DANGER	<p>ARC FLASH AND SHOCK HAZARD</p> <p>Follow ALL requirements in NFPA 70E for safe work practices and for Personal Protective Equipment.</p>
    DANGER	<p>DANGER</p> <p>Do not remove, destroy, or cover this label.</p> <p>Read instruction manual carefully before installing, operating, or servicing this equipment.</p> <p>High voltage and rotating parts will cause serious or fatal injury.</p> <ol style="list-style-type: none"> 1. Turn off and lock out power before service or maintenance. 2. Do not insert any object into fan cover, air inlet, or outlet windows before or during running. 3. Ground and protect per national electric code and local codes.
 WARNING	<p>HAZARDOUS VOLTAGE</p> <p>Disconnect power before servicing.</p>
 WARNING	<p>Do not operate this equipment without the guard installed.</p>
 WARNING	<p>Risk of explosion</p>
 WARNING	<p>WARNING</p> <p>This product can expose you to chemicals including lead and lead compounds, which are known to the State of California to cause cancer and birth defects or other reproductive harm. For more information go to www.p65warnings.ca.gov</p>
	<p>Connections may come loose during shipping and normal operation.</p> <p>Hydraulic, water, and electrical connections can come loose during shipping and normal operation. It is recommended that all connections are checked at installation and annually.</p>
 CAUTION	<p>Do not touch a hot surface.</p>
	<p>ATTENTION</p> <p>Interlock installed</p> <p>High-pressure cutting water is disabled when the top cover is open.</p>

	Correct direction of motor rotation (motor rotation arrow)
S/N	Serial number
V	Volts
Φ	Number of phases in a power system
Hz	Frequency (hertz)
FLA	Full-load current (amperage)
SCCR	Short-circuit current rating
OIL	Type of hydraulic fluid recommended
OIL VOL	Hydraulic fluid tank volume (liters)
(M) I_{max}	Primary motor maximum current draw (amperes)
(M) kW	Primary motor power output (kilowatts)
l/min	Maximum outlet flow rate (liters/minute)
MPa	Maximum outlet water pressure (megapascals)
Kg	Weight (kilograms)
IP	Ingress protection rating
P/N	Part number
CE	<p>The Conformité Européene (CE) mark affixed to a product signifies the manufacturer's declaration of conformity to applicable European directives and standards.</p> <p>Only those versions of Hypertherm products with a CE mark on or near the data plate have been tested for compliance with the applicable European directives, such as the Low Voltage Directive, the Electromagnetic Compatibility Directive, and the Machinery Directive.</p>
	Identifies the terminal of a protective earth (ground) electrode or a terminal intended to connect to an external conductor for protection against electric shock during a fault condition.
	Controls on
	Remote key switch off
	Remote key switch on
	Prefilter water pressure
	Postfilter water pressure
	<p>COMPRESSED AIR IN</p> <p>Compressed air that operates the bleed-down valve</p>
	<p>CUTTING WATER IN</p> <p>Low-pressure water from a water softener, a reverse osmosis system, a well, or a public utility</p>
	<p>CUTTING WATER OUT</p> <p>Water that has been pressurized by the intensifier for piercing or cutting</p>
	<p>WASTE WATER OUT</p> <p>Water from the bleed-down valve and the low-pressure system to a drain</p>

Symbols and marks

	<p>COOLING IN</p> <p>Water-cooled system: Low-pressure supply water or water from a chiller that goes to a heat exchanger</p> <p>Air-cooled system: Hydraulic fluid from an external heat exchanger</p>
	<p>COOLING OUT</p> <p>Water-cooled system: Low-pressure water from the heat exchanger that goes to a drain or goes to a chiller</p> <p>Air-cooled system: Hydraulic fluid that is sent to an external heat exchanger</p>
	<p>Cut pressure</p>
	<p>Pierce pressure</p>
	<p>Hydraulic pressure</p>

Measurements

Measurements in this manual are presented in International System of Units (SI) units followed by international units and US customary units in parentheses. This equipment is manufactured in the US, so a metric equivalent is not always available because of inexact conversion.

Section 1

Terminology

In this section

This section includes definitions for terms used in this and other HyPrecision manuals. Some terms could be applicable to other products.

1 – Terminology

air cooled

The system uses hydraulic fluid and an external heat exchanger to keep the pump cool

attenuator

A pressure vessel that compensates for pressure fluctuations and maintains a consistent output water pressure

AWG

American Wire Gauge, a standardized wire gauge system that is used in North America

bar

A unit of pressure: 1 bar equals 100 kPa or 14.5 psi or 100,000 N/m²

Btu

British thermal unit, a standard unit of energy equal to approximately 1,055 joules or 1,055 watt-seconds

Used in the United States and sometimes in the United Kingdom, the Btu measures the energy necessary to increase the temperature of 1 pound of water 1°F at sea level.

Energy-production or energy-transfer are frequently given in Btus per hour: 1 Btu/hr equals 0.293071 watts; 1 watt equals 3.4 Btu/hr

CNC

Computer numerical control, preprogrammed computer software controls the movement of a machine or tool

cooling mode

The pump idles with the intensifier off; hydraulic fluid flows through the pump at minimum pressure, the cutting-water solenoid is open, and if the system has a boost pump, the boost pump is on

cooling water

In a water-cooled system, low-pressure water flows through the heat exchanger to keep the hydraulic fluid cool

cSt

Centistoke, a measurement of kinematic viscosity; water has a viscosity of 1 centistoke or 1 mm²/second

cut-pressure mode

High-pressure water from the intensifier that is at cutting pressure

Refer to **pierce-pressure mode**.

dB(A)

A-weighted decibels, an expression of the relative loudness of sound in air as perceived by the human ear

dynamic seal

The high-pressure seal that is nearest the hydraulic center section; this seal touches the plunger

Refer to **static seal**.

energy source

A source of electric, mechanical, hydraulic, pneumatic, chemical, thermal, or other energy

1 – Terminology

energy-isolating device

A mechanical device that physically prevents the transmission or release of energy

Examples include a manually operated circuit breaker, a disconnect switch, or an equivalent device that blocks or isolates energy

Selector switches, emergency stop knobs, and other circuit control devices are not energy-isolating devices.

EP

Extreme pressure, a property of some types of grease; this grease is resistant to mechanical breakdown, oxidation, and heat

fault

The controller senses a condition that will cause a serious problem, a failure, or a possible failure condition

fitting

A coupling, a valve, or a gauge that stops, regulates, or controls the flow of water in a pipe

FLA

Full-load amperes (current)

ft·lbf

Foot-pound force, a unit that identifies the work or energy transferred when applying a force of 1 pound to an object through a distance of 1 foot: 1 ft·lbf equals 1.36 N·m or 1.36 joules

Refer to **joule**.

gate valve

Also known as a sluice valve, a knife valve, or a slide valve; controls the flow of liquid through a pipe

hard water

Water with dissolved minerals in it, usually calcium and magnesium

HEPA filter

High-efficiency particulate air filter, a mechanical air filter that catches particles that are 0.3 microns in diameter (1 micron = 1 millionth of a meter) or larger

The US National Institute for Occupational Safety and Health grades HEPA filters based on resistance to degradation from oil and level of efficiency (95%, 99%, and 99.97%).

high-pressure water (CUTTING WATER OUT)

Low-pressure supply water goes into the intensifier, where it is pressurized for piercing and cutting

hopper

A container that is wider at the top than at the bottom

hose

A flexible, hollow cylinder that is used to move low-pressure fluids; hoses typically have quick-disconnect fittings

Hose is sized by its inside diameter (ID).

Refer to **pipe**, **tube**, and **tubing**.

ID

Inner diameter, the diameter of the inside of a cylinder

1 – Terminology

impact wrench

Also known as an impact gun, air wrench, air gun, or rattle gun; a powered tool that supplies high torque to turn a socket

inrush current

Also known as input surge current or switch-on surge; the maximum instantaneous current that a motor uses when it is first turned on

ISO

International Organization for Standardization, an independent membership organization that develops voluntary industrial standards

JIC

Joint Industry Council, a type of hydraulic flare fitting used for connections in high-pressure fluid systems

The fitting is composed of a fitting, a flare nut, and a sleeve.

joule

A unit that identifies the work or energy transferred when applying a force of 1 newton to an object through a distance of 1 meter: 1 joule equals 1 N·m or 0.746 ft·lbf.

Refer to **ft·lbf**.

kPa

Kilopascal, a unit of pressure: 1 kPa equals 0.01 bar or 0.15 psi or 1,000 N/m²

lap

To use lapping film on a stainless-steel surface to make the surface very smooth and flat

lbf-ft

Pound force foot, the torque made when applying a force of 1 pound at a 1-foot distance from a perpendicular pivot point: 1 lbf-ft equals 12 lbf-in or 1.36 N·m

lbf-in

Pound force inch, the torque made when applying a force of 1 pound at a 1-inch distance from a perpendicular pivot point: 1 lbf-in equals 0.0833 lbf-ft or 0.113 N·m

lock out

Refers to practices and procedures that protect personnel from the starting of machinery or equipment, or the release of dangerous energy during maintenance or repair work

Lock-out devices hold energy-isolation devices in a safe or off position and can not be removed without a key or other unlocking mechanism or through special means, such as bolt cutters.

low-pressure water (CUTTING WATER IN)

Low-pressure water from a water softener, a reverse osmosis system, a well, or a public utility that is between the utility panel and the intensifier

Refer to **prefilter water** and **postfilter water**.

N/m²

Newtons per square meter, a unit of pressure: 1 N/m² equals 0.00001 bar or 0.001 kPa or 0.00015 psi

NFPA 70®

The National Fire Protection Association is a global organization that aligns standards and codes to protect personnel and property from fire and electrical dangers.

1 – Terminology

NFPA 70E®

The *Standard for Electrical Safety in the Workplace®*, is a standard that contains requirements for safe work practices to protect personnel from electrical dangers

NEC®

The National Electrical Code® is the United States codes and standards for electrical design, installation, and inspection

NLGI grade

National Lubrication Grease Institute, also known as a consistency number; identifies the relative hardness of grease – the higher the number, the harder the grease

NLPM

Normal liters per minute, a European measurement of the flow rate of a gas at a specified volume and temperature

Refer to **SLPM**.

Nm³

Normal cubic meter, the flow rate of a gas at a specified volume and temperature

noncondensing humidity

Water vapor that stays in vapor form instead of changing to water (condensation)

normal shutdown

The system turns off after completing a sequence of steps

Refer to **uncontrolled shutdown**.

NPT

National pipe thread taper, a common United States standard for tapered threads that are used on fittings and pipes

OD

Outer diameter, the diameter of the outside of a cylinder

OEM

Original equipment manufacturer, the manufacturer of machines that are sold directly to end users

overstroke

An overstroke fault occurs when the hydraulic piston travels faster than the pump can sustain.

overvoltage category

Also known as installation category; a standard that describes how much transient voltage, such as a spike, equipment can accept

pierce-pressure mode

Reduced-pressure water from the intensifier that is used to pierce material before cutting

Refer to **cut-pressure mode**.

1 – Terminology

pipe

A rigid, hollow cylinder that is used to move fluids; pipes are not always one piece from end to end; fittings include adapters, tees, and reducers; pipes have a pressure rating

Pipe is sized by wall thickness (schedule) and a standardized outer diameter (OD). The OD in millimeters is called nominal diameter (DN) and in inches it is called nominal pipe size (NPS). The actual physical OD can be larger than the nominal OD.

Refer to **hose**, **tube**, and **tubing**.

pollution degree

A safety classification that describes the environment in which a piece of electrical equipment operates

Underwriters Laboratories (UL) and the International Electrotechnical Commission (IEC) specifies pollution degree 3 as an environment with conductive pollution or dry nonconductive pollution that becomes conductive because of condensation. A pollution degree 4 environment has pollution that is persistently conductive because of dust or wet conditions.

postfilter water

Low-pressure water that is between the water filters and the intensifier

prefilter water

Low-pressure water that is between the utility panel and the water filters

psi

Pound-force per square inch, a unit of pressure: 1 psi equals 0.07 bar or 6.89 kPa or 6,895 N/m²

refrigeration ton

The heat transfer necessary at 0°C (32°F) to make 1 short ton (2,000 lb) of ice in 24 hours.

3.5 kW = 1 refrigeration ton = 12,000 Btu/hour

relative humidity

Also known as RH or ambient humidity; how much water vapor is in the air, given as a percentage

Water vapor condenses as the relative humidity nears 100%.

reverse osmosis

A method for treating water in which the water is pushed through a semipermeable membrane to remove impurities

RTV

Room-temperature vulcanization, silicone rubber is mixed with a curing agent to form a compound that is temperature- and thermal-resistant

SAE

Society of Automotive Engineers International, a professional association that aligns technical standards based on best practices in the aerospace, commercial vehicle, and automotive engineering industries

SAE Code 61 fittings are made for 207-bar or 20,700-kPa or 3,000-psi applications.

SAE Code 62 fittings are made for 414-bar or 41,400-kPa or 6,000-psi applications.

SLPM

Standard liters per minute, a USA measurement of the flow rate of a gas at a specified volume and temperature

Refer to **NLPM**.

1 – Terminology

static seal

The high-pressure seal at the output end of the high-pressure cylinder; the static seal does not touch the plunger

Refer to **dynamic seal**.

supply water

Water going to the pump from a water softener, a reverse osmosis system, a well, or a public utility

system integrator

An integrator of waterjet cutting systems that are sold directly to end users

technical drawings

System schematics and wiring diagrams that describe the system

total dissolved solids (TDS)

Dissolved solids refers to tiny particles in solution in water. TDS include hard elements such as iron, calcium, magnesium, and silica, which form deposits in high-pressure tubing and can damage check valves, seals, orifices, and other consumables.

total suspended solids (TSS)

Suspended solids refers to small, solid particles that are suspended in water. In HyPrecision waterjet pumps, filters remove these solids from the cutting water.

tube

A flexible, hollow cylinder that is used to move low-pressure fluids; a tube is one piece from end to end

Tubes are sized by outer diameter (OD) and wall thickness (WT or gauge).

Refer to **hose**, **pipe**, and **tubing**.

tubing

A rigid, hollow cylinder that is used to move high-pressure fluids; tubing is one piece from end to end; tubing typically has push-to-connect fittings

Tubing is sized by outer diameter (OD) and wall thickness (WT or gauge).

Refer to **hose**, **pipe**, and **tube**.

uncontrolled shutdown

The system turns off without completing an established sequence of tasks; this can occur when power is lost or when the **Emergency Stop** knob is pushed

Refer to **normal shutdown**.

union

A 3-part fitting that is made to join 2 pipes so that only 1 pipe must be turned when removing the union

VAC

Volts of alternating current

valve

A device used to control the rate of a fluid flowing in a pipe or a tube

VDC

Volts of direct current

warning

The controller senses a condition that could cause a problem or a failure

1 – Terminology

WASTE WATER OUT

Water from the bleed-down valve or the low-pressure system that goes to a drain

water cooled

The system uses low-pressure water and an internal heat exchanger to keep the pump cool

weep hole

A small hole in a high-pressure component that lets leaking water drain

Section 2

Product description

In this section

- Flow diagrams for water and hydraulic fluid
- Descriptions of the system and major components in the pump

i	Images in this manual are for reference purposes. It is possible that your product is not shown accurately.
	It is possible that not all of the information in this section applies to all pump models.

Flow of water and hydraulic fluid

These diagrams show a typical installation.

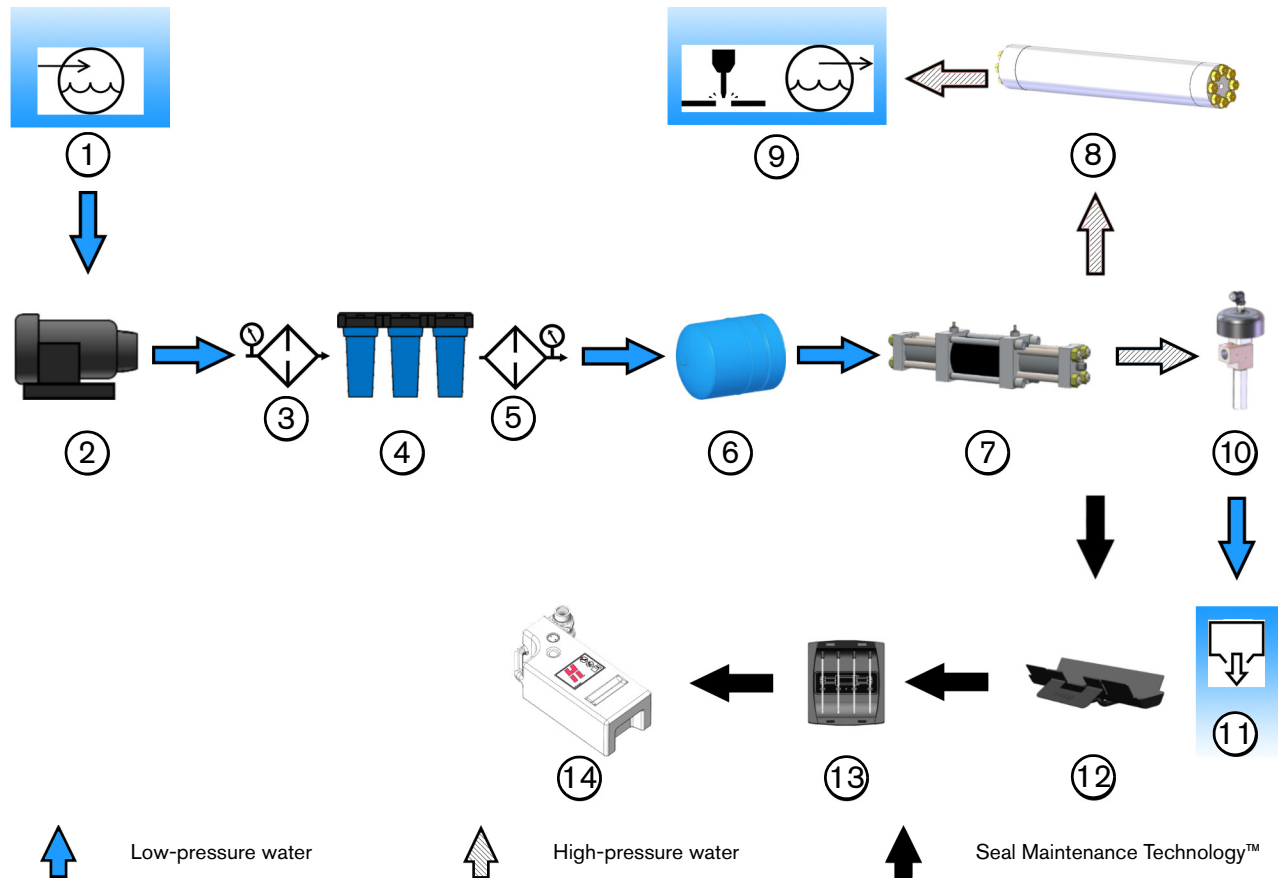

- 1** Utility panel: CUTTING WATER IN
Supply water from a water softener, a reverse osmosis system, a well, or a public utility goes into the pump.
- 2** Boost pump
Increases water pressure
- 3** Prefilter water gauge
- 4** Water filters
- 5** Postfilter water gauge
- 6** Water accumulator tank
- 7** Intensifier

- 8** Attenuator
- 9** Utility panel: CUTTING WATER OUT
High-pressure water goes from the intensifier to the cutting head.
- 10** Bleed-down valve
- 11** Utility panel: WASTE WATER OUT
Low-pressure water goes to a drain.
- 12** Drip tray
- 13** Seal Maintenance Indicator (SMI)
- 14** Dirty water container

Cooling loop

Compressing hydraulic fluid generates substantial heat that can cause damage to equipment and decrease the life of the fluid. Fluid that is too hot is thin, which accelerates wear on the parts, increases the formation of sludge, degrades the fluid, and decreases its lubrication and protective qualities. Increased temperature can mean that there is a problem with the cooling system.

The cooling loop keeps the hydraulic fluid at its optimum temperature.

Cooling loop for a water-cooled system (internal heat exchanger)

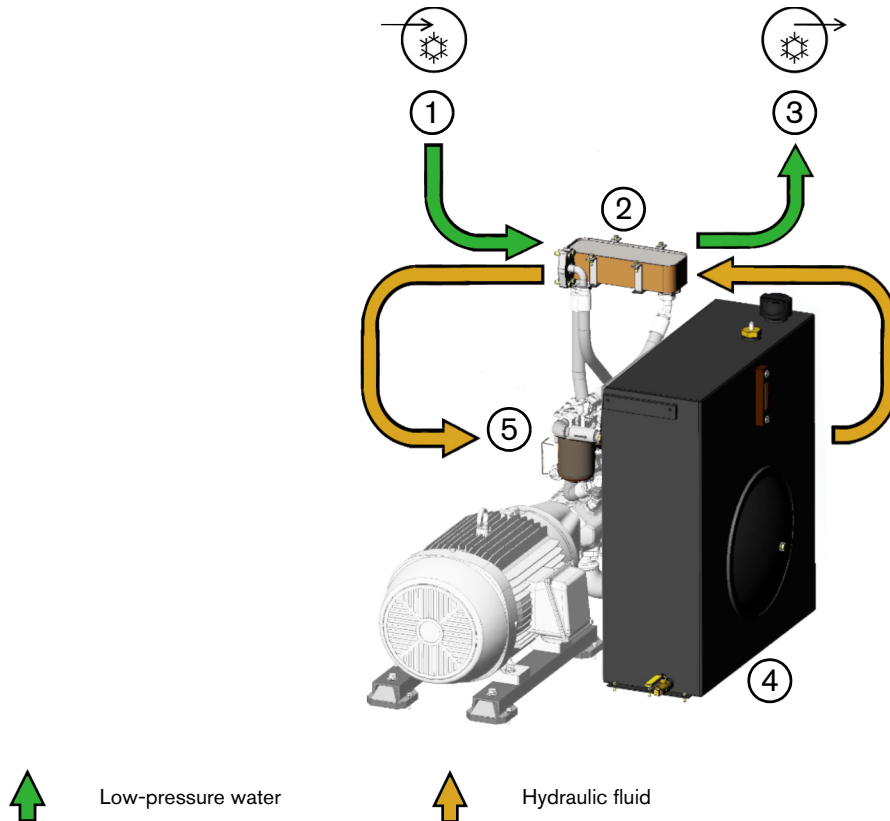

- 1** Utility panel: COOLING IN
Low-pressure supply water or water from a chiller goes to the heat exchanger.
- 2** Internal heat exchanger
- 3** Utility panel: COOLING OUT
Water from the heat exchanger goes to a chiller or a drain.

- 4** Hydraulic fluid tank
Hydraulic fluid goes from the tank to the gear pump (not shown). From the gear pump, the hydraulic fluid goes to the heat exchanger.
- 5** Hydraulic filter
The gear pump moves hydraulic fluid from the heat exchanger to the filter and then into the tank.

When the primary motor is operating, cooling water goes through the heat exchanger, transferring heat away from the hydraulic fluid to the cooling water.

2 – Product description

Cooling loop for an air-cooled system (external heat exchanger)

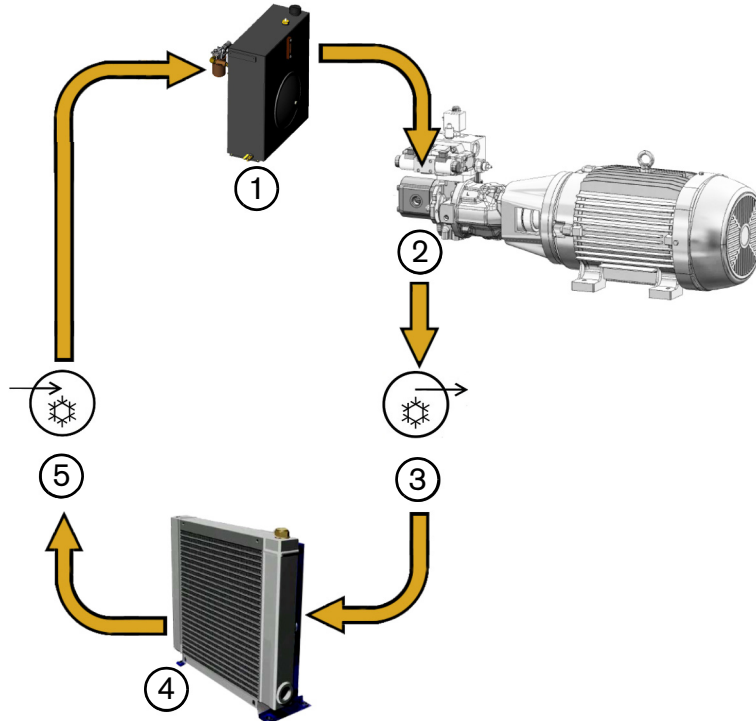

- 1** Hydraulic fluid tank
Hydraulic fluid goes from the tank to the gear pump.
- 2** Gear pump
From the gear pump, hydraulic fluid goes to the heat exchanger.
- 3** Utility panel: COOLING OUT
- 4** External heat exchanger
A fan keeps the hydraulic fluid cool.
- 5** Utility panel: COOLING IN
Hydraulic fluid goes from the heat exchanger to the hydraulic filter and then into the tank.

When the primary motor is operating, hydraulic fluid goes through the heat exchanger, where a fan pushes ambient air through the heat exchanger.

Pump exterior

Front view

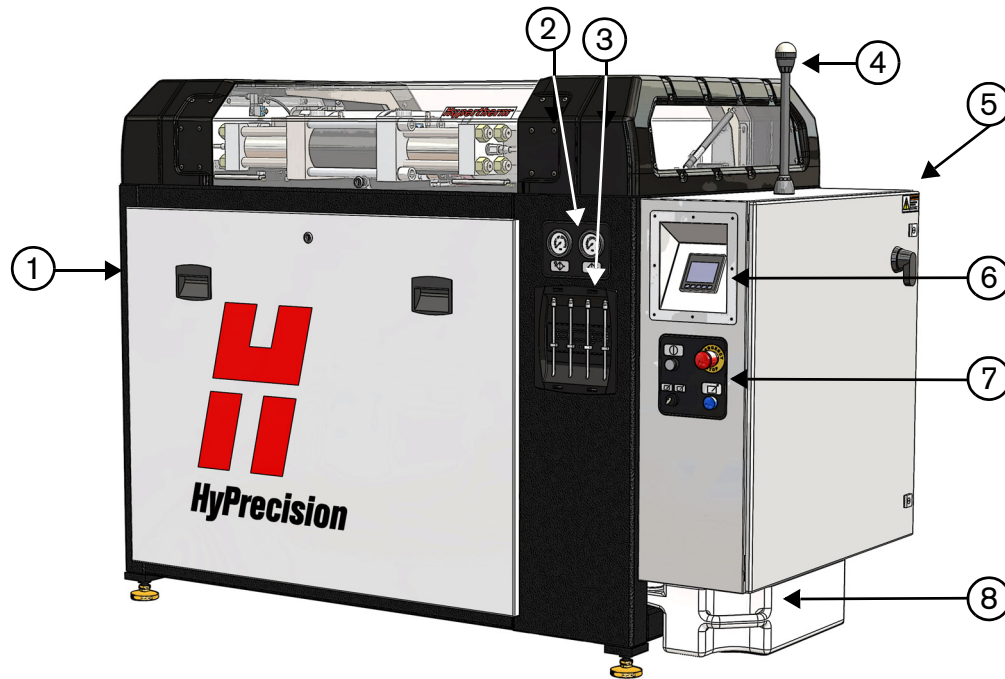

- | | | | |
|---|----------------------------------|---|-----------------------|
| 1 | Front panel | 5 | Electrical enclosure |
| 2 | Gauge panel | 6 | Operator interface |
| 3 | Seal Maintenance Indicator (SMI) | 7 | Operation panel |
| 4 | Beacon light | 8 | Dirty water container |

Panels

The front, rear, and side panels have locks to prevent access to system components during operation. Open the locks with a standard screwdriver.

Gauge panel

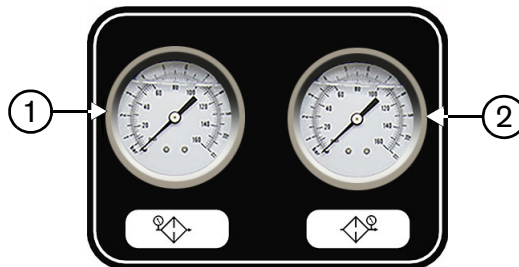

- 1 Prefilter water-pressure gauge
- 2 Postfilter water-pressure gauge

Prefilter water-pressure gauge

The prefilter water-pressure gauge shows the water pressure before the water goes through the filters.

Postfilter water-pressure gauge

The postfilter water-pressure gauge shows the water pressure after the water goes through the filters.

2 – Product description

Seal Maintenance Indicator (SMI)

Seal Maintenance Technology™ optimizes seal life. When an intensifier seal begins wearing out, water and hydraulic fluid leak from the weep holes in the high-pressure ends.

A drip tray, which is attached to the bottom of each side of the intensifier, collects fluid leaking from weep holes.

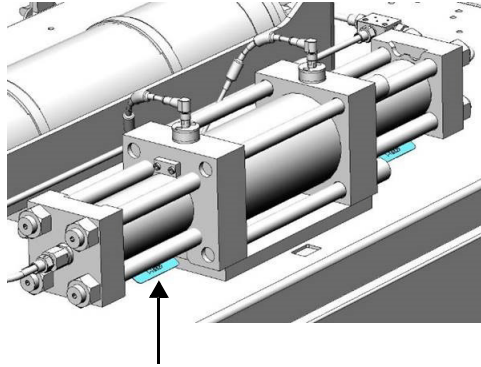

From the drip tray, fluid flows through a clear tube to the SMI. When a drip passes an optical sensor, a blue LED illuminates, showing which of the weep holes on the intensifier is the source of the drip.

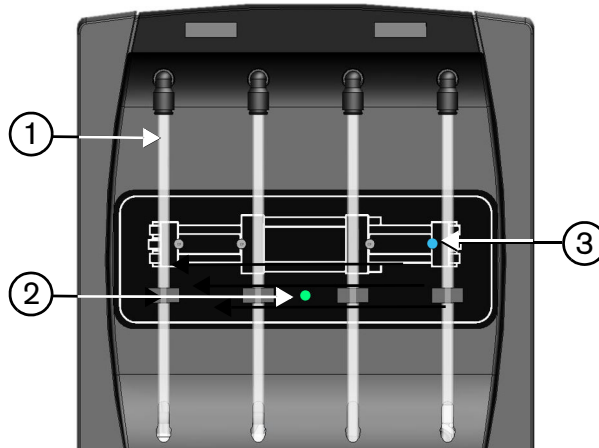

1 SMI tube

2 Power LED (green)

3 Drip sensor LED (blue)

The SMI monitors the leak rate from the intensifier. When a seal failure is possible, a warning shows on the operator interface and the beacon light flashes.

The SMI is a monitoring device, not a measuring device.

Beacon light

The beacon light flashes green during the start sequence. The light is steady green when the system is at operating pressure.

An amber light flashes to signal a warning condition.

A red light flashes to show that a fault has occurred.

The light is off when the pump is in cooling mode.

2 – Product description

Electrical enclosure

Motor starters, thermal overload relays, and breakers are in the enclosure.

The primary breaker disconnect lever is on the electrical enclosure.



Primary breaker disconnect lever

Operator interface

On the operator interface, a series of screens shows equipment status and lets the operator control the pump and the intensifier.

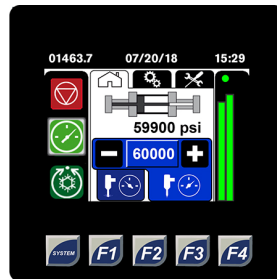

The screens are described in detail in other sections of this manual.

2 – Product description

Operation panel

The operation panel turns the control circuit in the pump on and off and controls local and remote pump operation.

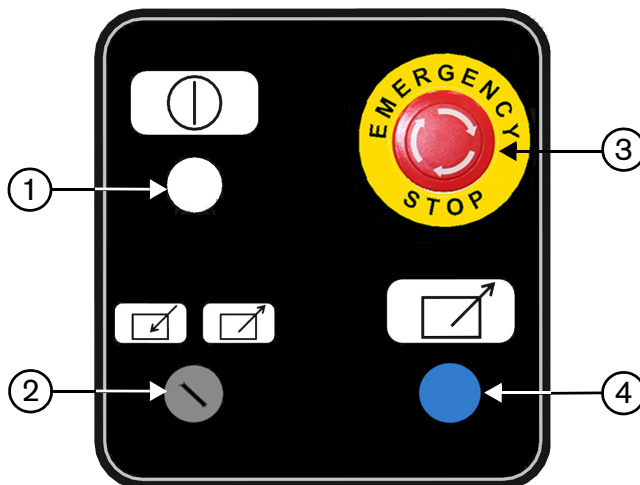

1 CONTROLS ON button

2 LOCAL/REMOTE key switch

3 **EMERGENCY STOP** button

4 REMOTE ON indicator light

Refer to **Operator interface: Operation screens** on page 58 for information.

Dirty water container

Water and hydraulic fluid captured in the drip trays goes to the dirty water container found under the electrical enclosure.

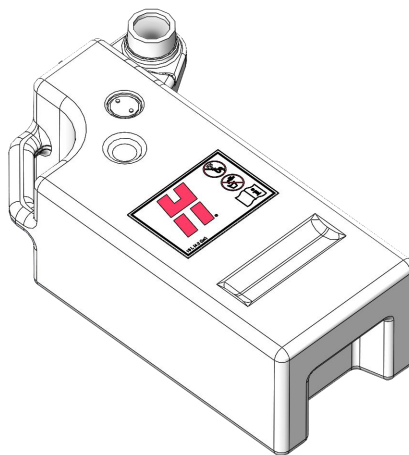

2 – Product description

Rear view

Utility panel

The air and water fittings are found on the utility panel.



HyPrecision P-15/P-30/P-50 pump



HyPrecision P-50S/P-60S/P-75S pump



COMPRESSED AIR IN
Compressed air operates the bleed-down valve.



WASTE WATER OUT
This hose carries water from the bleed-down valve and the low-pressure system to a drain.



COOLING IN

Water-cooled system
This line carries low-pressure supply water from the local utility or a chiller to the pump's cooling loop.

Air-cooled system
This hose carries hydraulic fluid from the external heat exchanger to the hydraulic fluid tank.



CUTTING WATER OUT
This tubing carries high-pressure water from the pump to the cutting table.

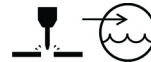

CUTTING WATER IN
This line carries low-pressure water from a water softener, a reverse osmosis system, a well, or a public utility to the pump.



COOLING OUT

Water-cooled system
This line carries low-pressure water from the heat exchanger to the chiller or to the drain.

Air-cooled system
This hose carries hydraulic fluid from the hydraulic fluid tank to an external heat exchanger.

The diagram on page 36 shows the flow of water through the pump system.

i	Cooling in and cooling out are sometimes referred to as the cooling loop. The cooling loop keeps the hydraulic fluid in the pump at its optimal temperature.
----------	---

2 – Product description

Top deck

Top cover

A hinged top cover protects components on the top deck from dirt and debris. Open the lock with a standard screwdriver.

HyPrecision P-50S/P-60S/P-75S pumps have a top cover with transparent panels.

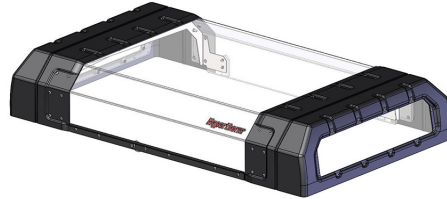

An optional top cover is available for HyPrecision P-15/P-30/P-50 pumps.



Electrical interlock (optional on all models with top covers)

The electrical interlock is part of the emergency stop circuit. If the top cover is opened while the pump is on, the result is the same as pushing the **EMERGENCY STOP** button. Refer to **Stop the pump** on page 67.

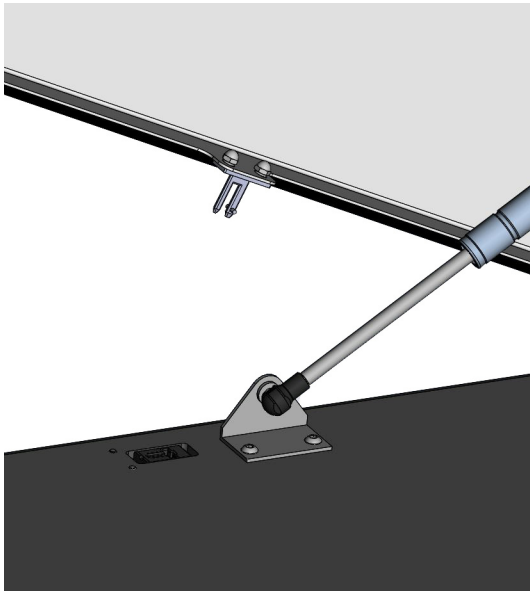

HyPrecision P-15/P-30/P-50 pump

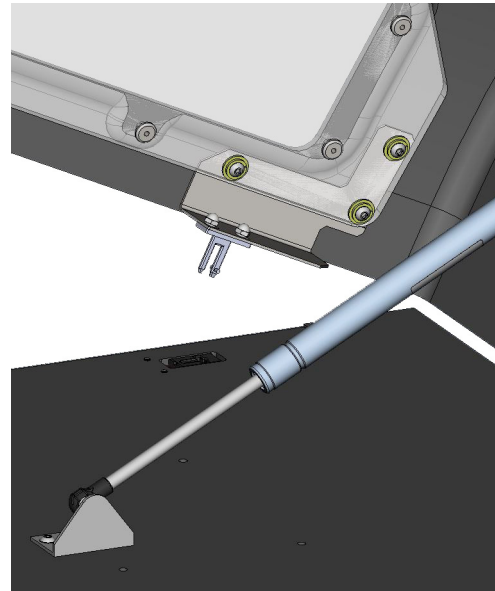

HyPrecision P-50S/P-60S/P-75S pump

An override key is provided for access to the components on the top deck.

2 – Product description

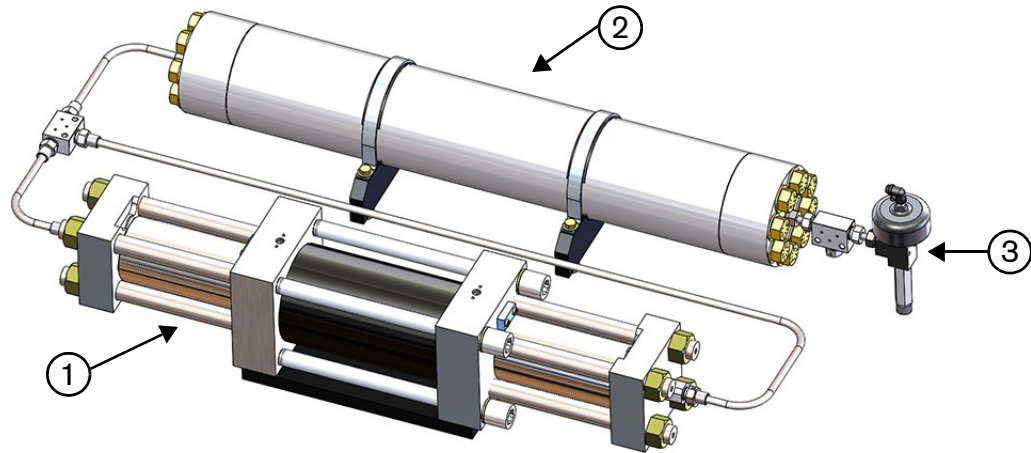

- 1 Intensifier
- 2 Attenuator

- 3 Bleed-down valve

Intensifier

Low-pressure supply water goes into the intensifier, where it is pressurized for piercing and cutting.

The hydraulic center section contains hydraulic fluid, which is used to compress water in the high-pressure ends.

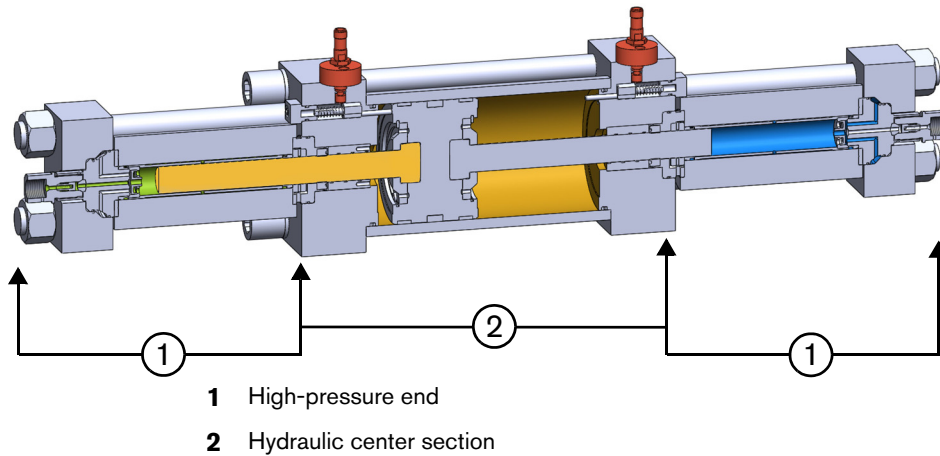

- 1 High-pressure end
- 2 Hydraulic center section

The pressurized water exits the high-pressure end through a check valve and goes to the attenuator.

Attenuator

The piston stroking in the hydraulic center section of the intensifier causes a brief change of water pressure. The attenuator compensates for high-pressure water fluctuations and maintains a consistent output pressure.

The 2-liter attenuator has a guard installed. The attenuator guard is intended to keep personnel safe from studs or end caps, which can become projectiles if the attenuator fails.

Bleed-down valve

The bleed-down valve is a normally open, air-actuated dump valve. The valve releases high-pressure water from the system when the pump is turned off or when the operator changes from cut mode to pierce mode.

Pump interior

Front view

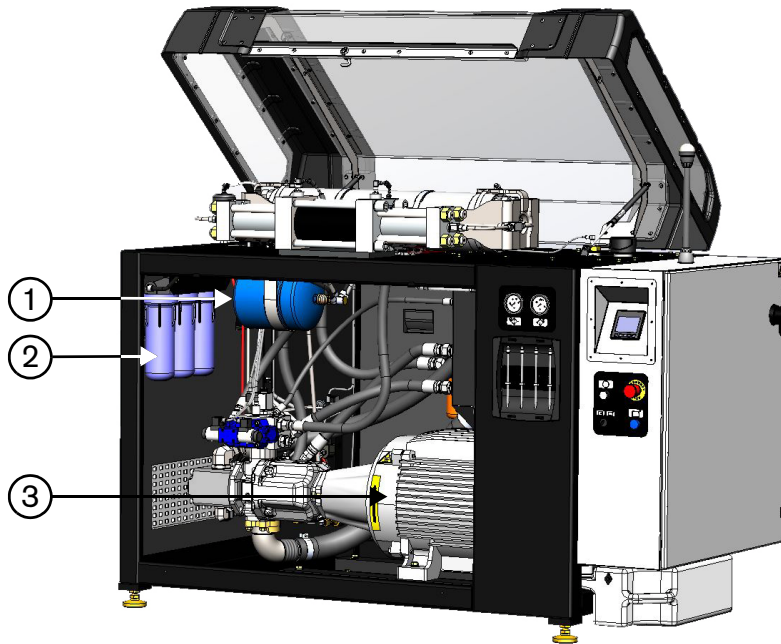

1 Water accumulator tank

2 Water filters

3 Primary motor

Water accumulator tank

This is a closed water chamber with a pressurized air bladder. It evens out low-pressure water flow to the intensifier, and maintains a consistent output water pressure.

Water filters

Water filters remove impurities from the supply water before it goes to the intensifier.

HyPrecision P-15/P-30/P-50 pumps have 2 water filters. HyPrecision P-50S/P-60S/P-75S pumps have 3.

2 – Product description

Primary motor

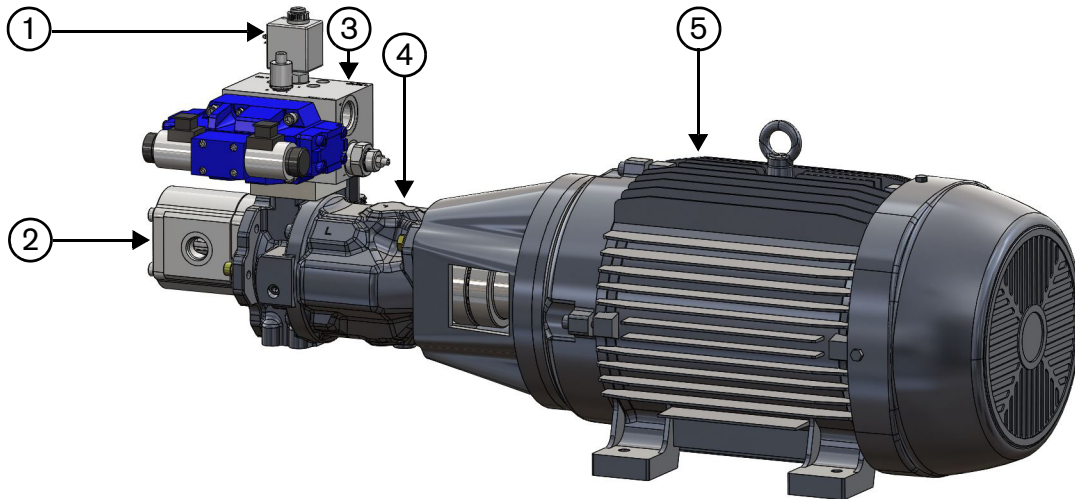

- | | | | |
|---|----------------------------|---|----------------|
| 1 | Proportional control valve | 4 | Hydraulic pump |
| 2 | Gear pump | 5 | Primary motor |
| 3 | Hydraulic manifold | | |

Proportional control valve

Electronic proportional pressure control is a closed-loop monitoring system. It adjusts pressure when changes are sensed, such as when the operator enters a water pressure target change on the operator interface pump or at the CNC.

A hydraulic pressure sensor gives feedback to the controller to let the system increase decrease the pressure to the cut setpoint or the pierce setpoint. The controller gradually increases pressure in the system. This reduces mechanical stress on the intensifier.

Gear pump

Compressing hydraulic fluid generates heat that can cause damage to equipment and decrease the life of the fluid. The gear pump is part of the cooling loop. It moves hydraulic fluid from the hydraulic fluid tank to the heat exchanger. The hydraulic fluid passes through a hydraulic filter and then goes to the hydraulic fluid tank.

Hydraulic manifold and hydraulic pump

The hydraulic pump pressurizes fluid from the hydraulic fluid tank. The pressurized fluid goes through the hydraulic manifold, which contains a shift valve that delivers hydraulic fluid to alternating sides of the intensifier.

Hydraulic fluid from the hydraulic center section in the intensifier goes to the hydraulic fluid tank through the hydraulic manifold.

The hydraulic manifold also houses a hydraulic transducer, which monitors hydraulic pressure in the system. A hydraulic relief valve sends hydraulic fluid back to the hydraulic fluid tank when the pressure is too high.

Primary motor

The primary motor drives the gear pump and the hydraulic pump.

2 – Product description

Rear view

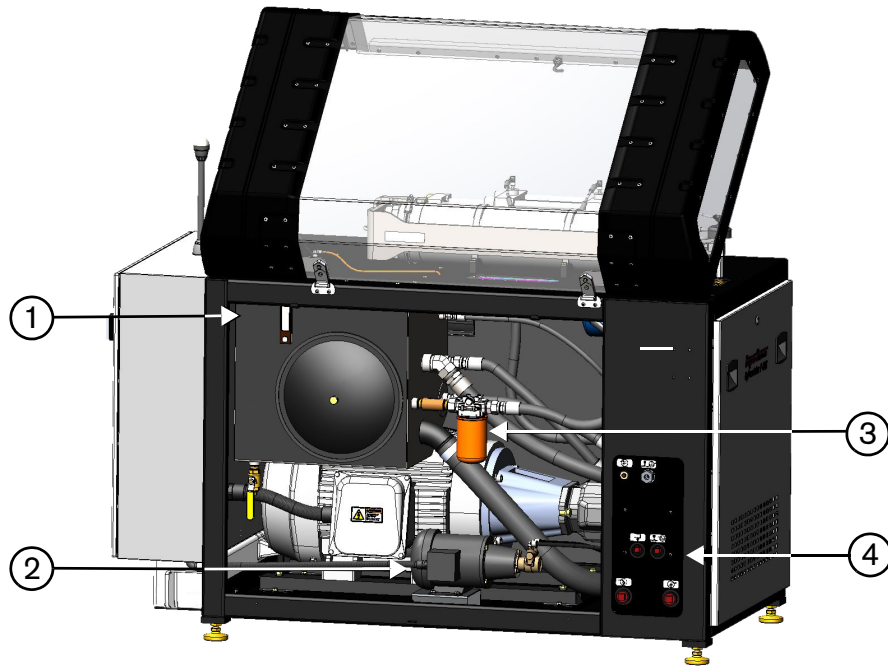

- 1 Hydraulic fluid tank
- 2 Boost pump

- 3 Hydraulic fluid filter
- 4 Water manifold

2 – Product description

Hydraulic fluid tank

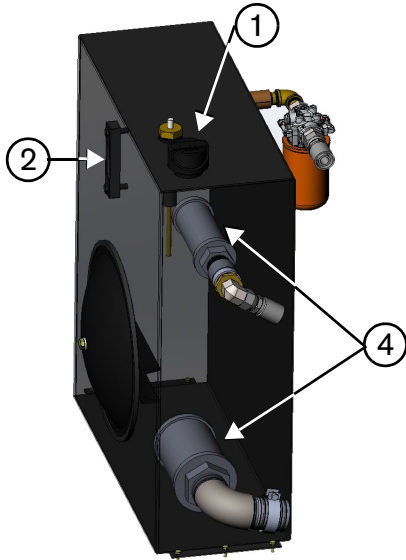

HyPrecision P-15/P-30/P-50 pump

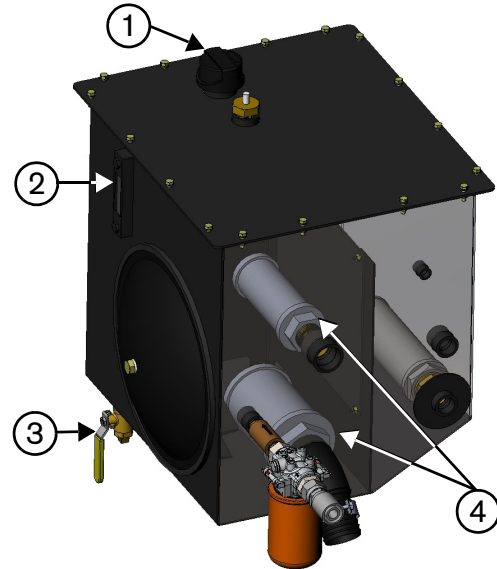

HyPrecision P-50S/P-60S/P-75S pump

- 1 Filler-breather cap
- 2 Sight gauge

- 3 Drain valve
- 4 Suction strainer

The filler-breather cap keeps airborne contamination out of the tank and prevents pressure from building up in the tank. It also gives access to the tank for adding hydraulic fluid.

A temperature sensor and a level sensor in the tank monitor the hydraulic fluid. Use the sight gauge to observe the hydraulic fluid level and quality.

Use the drain valve to drain the tank.

Suction strainers prevent contamination from entering the primary pump and the gear pump.

Boost pump

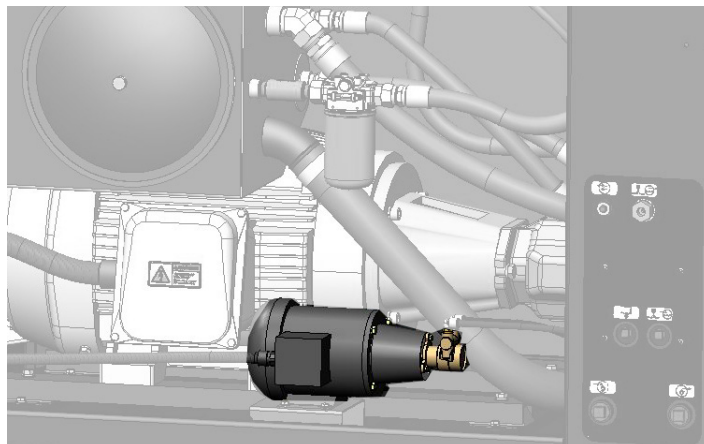

A minimum supply water pressure is necessary to operate the pump. A boost pump increases the water pressure to a value higher than the minimum requirement.

When the intensifier starts to stroke, the boost pump turns on. When there is no demand for cutting water, the boost pump turns off.

2 – Product description

Hydraulic fluid filter

This filter removes contamination from the hydraulic fluid.

Water manifold

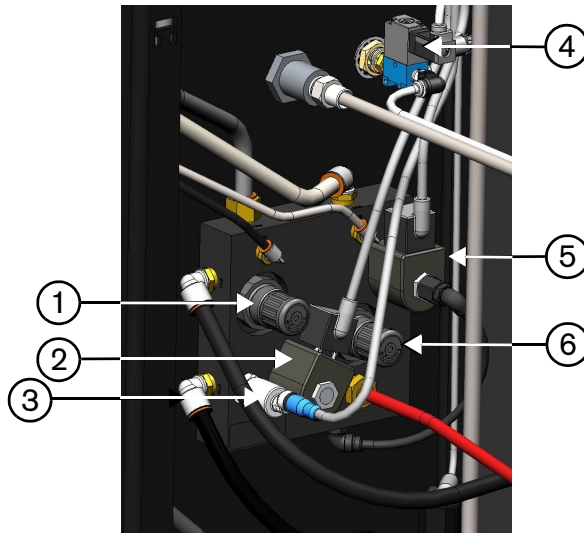

- 1 Boost pump pressure regulator
- 2 Supply cutting water solenoid
- 3 Low-pressure transducer

- 4 Bleed-down valve solenoid
- 5 Low water-pressure water dump valve
- 6 Low-pressure water relief valve

Boost pump pressure regulator

This knob lets the user adjust boost pump pressure.

Supply cutting water solenoid

The solenoid controls the cutting water coming into the system.

Low-pressure water dump valve

The valve closes to maintain water pressure while cutting. It opens to release pressure when the pump turns off.

Bleed-down valve solenoid

This solenoid opens and closes the bleed-down valve.

Low water-pressure transducer

The transducer monitors the manifold water pressure.

Low-pressure water relief valve

The relief valve prevents water in the system from being too high. When the valve opens, water goes to the drain.

Section 3

Optional equipment

These optional items are available for HyPrecision Predictive waterjet pumps.

All HyPrecision pump models

External heat exchanger

Standard pumps have a water-cooled heat exchanger. In an air-cooled system, the temperature sensor in the hydraulic fluid tank turns on an external heat exchanger.

Electrical interlock

An electrical interlock on the top cover prevents access to the components on the top deck while the system is pressurized.

The interlock is connected to the emergency-stop circuit. When the top cover is opened, the pump switches to emergency-stop mode and bleeds off all pressure.

A top cover is standard on HyPrecision P-50S/P-60S/P-75S pumps and optional for HyPrecision P-15/P-30/P-50 pumps.

HyPrecision P-15/P-30/P-50 pumps

Steel top cover

A top cover protects the components on the top deck from dirt and debris that collects during normal operation. This top cover does not have a transparent panel.

External boost pump

The pump will not operate satisfactorily if the supply water pressure is too low for the pump to get to operating pressure. A boost pump increases the water pressure to a value higher than the minimum requirement.

Section 4















Operation

In this section









- Safety
- Do a preoperation inspection
- Turn on the utilities
- Use the controls
 - Operation panel
 - Operator interface: Operation screens
- Operate the pump remotely
- Operate the pump locally
 - Run mode
 - Cooling mode
- Stop the pump

i	Images in this manual are for reference purposes. It is possible that your product is not shown accurately.
	It is possible that not all of the information in this section applies to all pump models.

Safety

	<p>Refer to the instruction manual. Read and understand all of the safety guidelines in this manual.</p>
 DANGER	<p>A waterjet is a cutting tool. Keep away from high-pressure streams and leaks. Pressurized fluid can cause injuries.</p> <p>A high-pressure injection injury is a surgical emergency. Get medical treatment immediately for all high-pressure waterjet injuries.</p> <p>Delayed treatment can cause injuries or death. Abrasive waterjets eject a mixture of water and abrasive materials that can be injected into body tissues, leading to a dangerous infection.</p>
 DANGER	<p>DANGEROUS VOLTAGE/RISK OF SHOCK</p> <p>To reduce the risk of injuries or death, wear approved protection and obey safety recommendations when doing work with electricity.</p>
 DANGER	<p>Do not stand in line with high-pressure fittings when operating this equipment. If a high-pressure fitting fails, it can cause a stream of water or hydraulic fluid to eject from the system with force.</p>
 WARNING	<p>Keep a restricted-access area clear that larger than the maximum movement range of the cutting equipment's moving parts.</p>
 WARNING	<p>Personal protective equipment is recommended. If you do not use personal protective equipment, there is a risk of injury or death.</p>
 WARNING	<p>Permit only approved personnel to operate, maintain, and repair this machinery.</p>
 WARNING	<p>Do not leave waterjet cutting equipment unattended while it is operating.</p>
 WARNING	<p>Do not operate the pump without the shaft access cover and all other safety devices correctly installed.</p>
 WARNING	<p>Make sure that all connections, fasteners, locking devices, hoses, and fittings are tight before operation.</p>
 WARNING	<p>Do not block or remove warnings, cautions, or instructions.</p>
 CAUTION	<p>Do not touch a hot surface.</p> <p>Water leaking from a high-pressure fitting or the bleed-down valve can be hot.</p>
  CAUTION	<p>High-pressure water can cause eye injuries. Wear approved eye protection when operating or doing work near this equipment.</p>

4 – Operation

  CAUTION	<p>This waterjet equipment could make more noise than is permitted by national or local codes. When this intensifier is operating, the noise level is 75 dB(A) to 80 dB(A). Water flow rate, pipe layout, and the acoustical characteristics of the building have an effect on noise level.</p> <p>Long periods of exposure to noise can cause permanent hearing loss. Wear approved ear protection and control exposure time when operating or doing work near this equipment.</p>
  CAUTION	<p>High-pressure water can cause cuts, abrasions, and punctures.</p> <p>Precision parts can have sharp corners or edges.</p> <p>Wear approved hand protection when operating or doing work near this equipment and when touching parts.</p>
  CAUTION	<p>Some materials can cause airborne contamination or particles when cut. Wear approved respiratory protection when operating or doing work near this equipment.</p>
	<p>Obey all safety requirements and applicable safety laws and regulations.</p>
	<p>Keep the work area clean and dry. Clean fluid spills immediately. Use catch basins under areas where water or hydraulic fluid can spill during maintenance or repair procedures.</p>

Do a preoperation inspection



WARNING

Make sure that all connections, fasteners, locking devices, hoses, and fittings are tight.

- Look for leaks, deterioration, damage, or other conditions that can interfere with operation.
- Look at the sight gauge on the hydraulic fluid tank. Add hydraulic fluid, if necessary.
- Close all doors and replace all panels and covers, including access covers.
- Make sure that all warning decals are visible and legible.

Turn on the utilities

1. Turn ON the electrical breaker.
2. Turn ON the water to the pump.
3. Monitor for leaks.
4. Turn ON the compressed air supply.
5. Turn ON the electrical main.
6. Turn the primary breaker disconnect lever on the electrical enclosure door to ON.

The operator interface screen is on when the pump is energized.

Use the controls

Operation panel

The operation panel turns the control circuit in the pump on and off and controls local and remote pump operation.



CONTROLS ON

This turns on the control circuit in the pump.



LOCAL/REMOTE

When the key switch is in the LOCAL position, the operator interface is used to operate the pump.



When the key switch is in the REMOTE position:

- The remote source, such as a computer numerical control (CNC) operator console, controls the pump.
- Most of the functions on the operator interface are not available.



EMERGENCY STOP

The button turns off the control circuit in the pump.

When this button is pushed:

- The control circuit turns off, which turns off the pump, the primary motor, and the intensifier.
- The bleed-down valve opens to release high-pressure water from the system.
- The low-pressure water valve opens to release low-pressure water from the system.



REMOTE ON

When the LOCAL/REMOTE key switch is in the REMOTE position, this indicator light is on.

Operator interface: Operation screens

The operation screen on the operator interface lets the user:

- turn the pump on or off.
- set or change the water pressure.
- select the operating mode (cut or pierce).
- monitor the status of the intensifier.

Primary operation screen

These elements are on most screens.

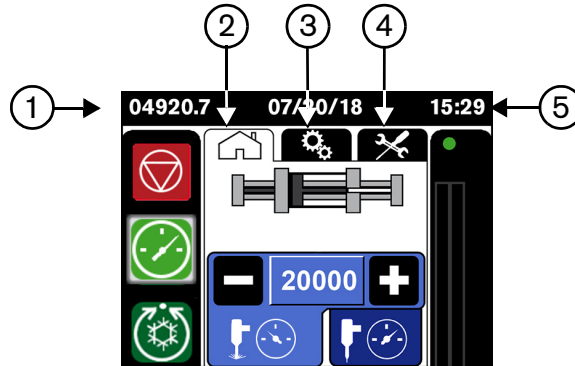

- | | |
|--|--|
| <p>1 Hour meter
This shows the total hours the pump motor has been in operation.</p> <p>2 Primary operator screen symbol</p> <p>3 Adjustments screen symbol
Refer to Operator interface: Adjustment screens on page 216.</p> | <p>4 Maintenance screen symbol
Refer to Operator interface: Maintenance screens on page 127.</p> <p>5 Date and time</p> |
|--|--|

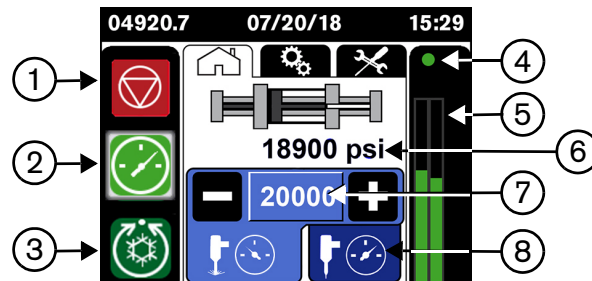

- | | |
|--|---|
| <p>1 STOP
Touch this symbol to stop the pump.</p> <p>2 RUN
Touch this symbol to start the pump.</p> <p>3 COOLING MODE
Touch this symbol to operate the pump with the intensifier off.</p> | <p>4 Intensifier status indicator</p> <p>5 Intensifier stroke indicator</p> <p>6 Output water pressure</p> <p>7 Target water pressure</p> <p>8 Pierce-pressure mode (shown on) / cut-pressure mode</p> |
|--|---|

Intensifier status indicator and stroke indicators

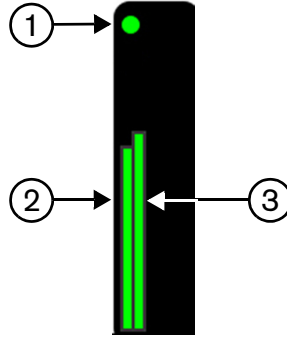

1 Intensifier status

2 Intensifier stroke rate to the left

3 Intensifier stroke rate to the right

The intensifier status can be enabled (green) or not enabled (red).

The bars show the intensifier's stroke rate.

- A green bar shows that the intensifier stroke rate is within the permitted range.
- A yellow bar shows that the stroke rate is at the limit of the permitted range.
- A red bar shows that the intensifier is overstroking.

Output water pressure

This shows the actual water pressure in the system.

Target water pressure

This is the water pressure set by the user.

Pierce-pressure mode and cut-pressure mode

Touch these symbols to operate the pump in cut-pressure mode or pierce-pressure mode.

The pressure adjustment screen lets the user enter the setpoints for pierce-pressure mode and cut-pressure mode. The adjusted pressure is saved in the controller settings.

To adjust the pressure, touch the applicable field and enter a value.

Operate the pump remotely

Turn on the pump

The pump is on when the primary motor is operating.

The primary motor drives 2 pumps. A hydraulic pump moves hydraulic fluid to the intensifier. A gear pump moves hydraulic fluid through the cooling loop.

1. On the operation panel, make sure that the key switch is set to LOCAL.
2. Push the CONTROLS ON button
3. Turn the key switch to REMOTE.

Start the pump

Refer to the OEM's instructions for turning the pump on.

Operate the pump

Refer to the OEM's instructions for operating the pump from a remote source.

Stop the pump

Refer to **Stop the pump** on page 67.

Operate the pump locally

Turn on the pump

The pump is on when the primary motor is operating.

The primary motor drives 2 pumps. A hydraulic pump moves hydraulic fluid to the intensifier. A gear pump moves hydraulic fluid through the cooling loop.

1. On the operation panel, make sure that the key switch is set to LOCAL.
2. Push the CONTROLS ON button.

Start the pump

On the operator interface, touch the RUN symbol.

- The controller puts the pump in start mode. The start sequence is fully automated.
- The beacon light flashes green.
- A green progress bar shows on the screen.

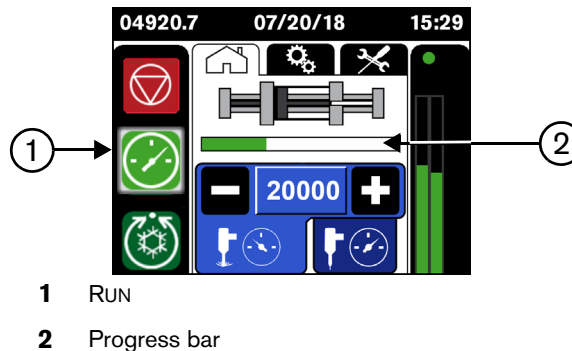

The start sequence timers are adjustable. Refer to **Start-procedure Timers** on page 219 for information.

Stage 1: Increase the supply water pressure

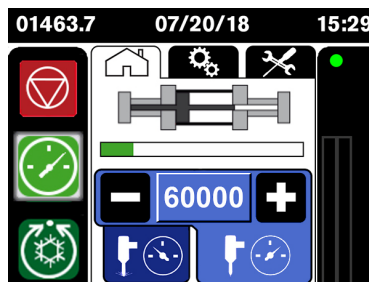

1. The primary motor starts.
2. The beacon light flashes green.
3. The hydraulic pump operates at the minimum pressure until stage 4.
 - The default is 17 bar (250 psi).
 - The intensifier does not stroke.
4. When the pressure is at the water manifold pressure setpoint, the Supply Water timer starts.

The timer is set at 5 seconds by default.
5. Water pressure in the system increases.

4 – Operation

6. The timer expires.

If the supply water pressure is not at the water manifold pressure setpoint after 20 seconds:

- The start sequence stops.
- A **Low Supply Water Pressure** alarm shows on the screen.
- The beacon light flashes red.
- The system goes into cooling mode and stays at the minimum pressure.

Find the cause of the low supply water pressure and start the pump again.

7. The start sequence continues to stage 2.

Stage 2: Remove air from the system.

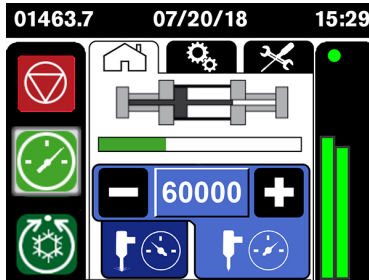

1. The intensifier starts stroking.
2. The Bleed Valve timer starts.
The timer is set at 5 seconds by default.
3. The intensifier pushes water through the system, which sends air out through the bleed-down valve.
4. The timer expires.
5. The start sequence continues to stage 3.

Stage 3: Fill the system with water

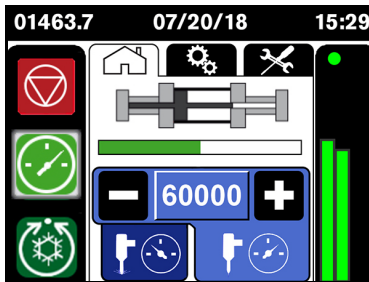

1. The bleed-down valve closes.
2. The Hydraulics timer starts.
The timer is set at 5 seconds by default.
3. The intensifier strokes, which increases water pressure in the system.

4 – Operation

4. The timer expires.

- If the time between intensifier strokes is longer than the Intensifier timer setpoint, pressure in the system is sufficient.
- The timer is set at 1.5 seconds by default.

If the time between intensifier strokes is shorter than the Intensifier timer, pressure in the system is too low.
A **Start Warning: Hydraulics** alarm shows on the screen. The beacon light flashes amber.

5. The start sequence continues to stage 4.

Stage 4: Increase the pressure to the pierce pressure setpoint

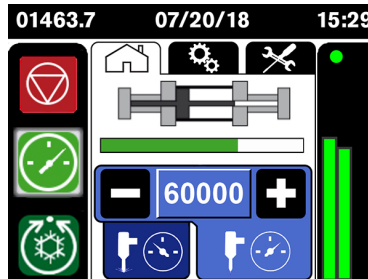

1. The hydraulic pressure increases to the pierce pressure setpoint.
2. The Pierce timer starts.

The timer is set at 5 seconds by default.

3. The intensifier strokes to increase water pressure in the system.
4. The timer expires.

If the time between intensifier strokes is longer than the intensifier timer setpoint, pressure in the system is sufficient.

If the time between intensifier strokes is shorter than the Intensifier timer, pressure in the system is too low.
A **Start Warning: Ramp to Cut Pressure** alarm shows on the screen. The beacon light flashes amber.

5. If the pump is set to cut pressure, the start sequence continues to stage 5.

If the pump is set to pierce pressure, the start sequence is complete. Refer to **The start sequence is complete** on page 64.

4 – Operation

Stage 5: Increase the pressure to the cut pressure setpoint

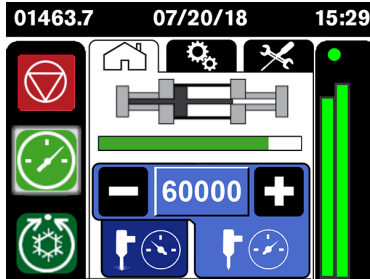

1. The hydraulic pressure increases.
2. The Cut timer starts.
The timer is set at 5 seconds by default.
3. The intensifier strokes to increase water pressure in the system.
4. The timer expires.

If the time between intensifier strokes is longer than the Intensifier timer setpoint, pressure in the system is sufficient..

If the time between intensifier strokes is shorter than the intensifier timer, pressure in the system is too low.
A *Start Warning: Ramp to Pierce Pressure* alarm shows on the screen. The beacon light flashes amber.

The start sequence is complete

The pump is at operating pressure and is ready to use.

- The beacon light is steady green.
- The primary motor is on.
- The hydraulic pump is on.
- The intensifier is on.
- The output water pressure shows on the screen.

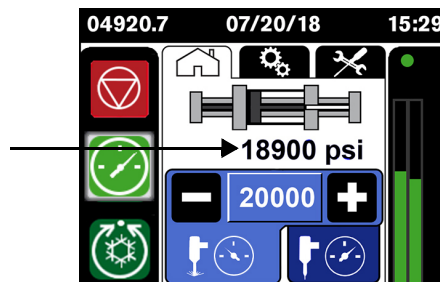

Operate the pump

Run mode

Set the water pressure target

1. On the operator interface, touch these symbols to select pierce-pressure mode or cut-pressure mode.

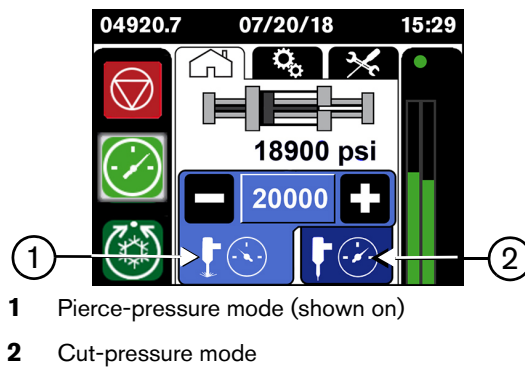

2. There are 2 ways to change the water pressure target on the operator interface.
 - a. Touch the - symbol or the + symbol to change the water pressure target in preset increments.

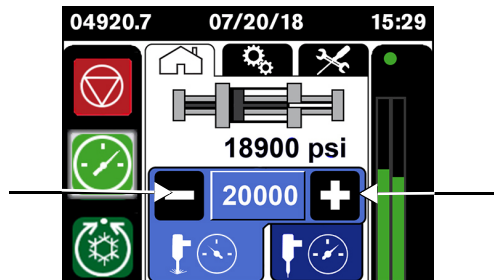

The increments can be changed. Refer to **Pressure Adjustments** on page 220.

- b. Touch the water pressure target field.

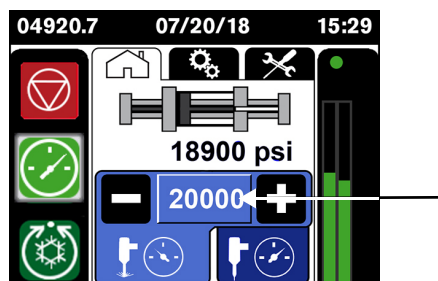

A numeric keypad opens.

4 – Operation

- c. Type the number and touch **Enter**.

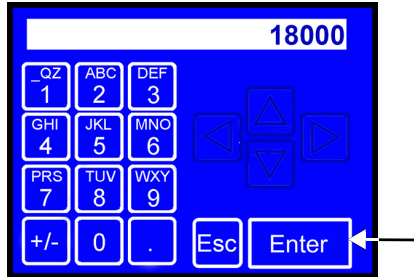

Pierce pressure is typically lower than 1,380 bar (138,000 kPa / 20,000 psi).

The minimum water pressure target is 345 bar (34,500 kPa / 5,000 psi). If the water pressure is set to a lower value, the pump operates at the minimum setpoint. If the pressure is set to 0, an alarm shows on the screen.

Cooling mode

Cooling mode operates the pump with the intensifier off. This mode is useful for some maintenance procedures.

The pump goes into cooling mode automatically:

- When the system encounters a level 1 fault condition
- After a specified time (Idle Time) without the intensifier stroking

On the operator interface, touch the COOLING MODE symbol.

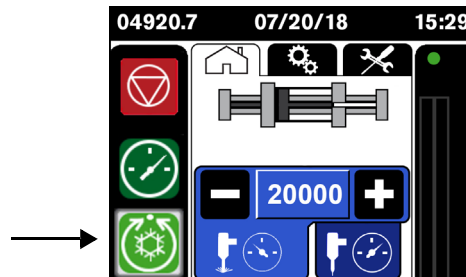

- The bleed-down valve opens to release high-pressure water from the system.
- The primary motor is on.
- The hydraulic pump operates at minimum pressure.
- The intensifier is off.

Stop the pump

Emergency

 WARNING	The EMERGENCY STOP button does not disconnect main electrical power from the machine.
---	--

The electrical interlock is part of the emergency stop circuit. If the top cover is opened while the pump is on, the result is the same as pushing the **EMERGENCY STOP** button.

The emergency stop is intended for stopping the controls immediately to prevent injury or to reduce the risk of injury to personnel, machinery, or work in progress. It is not the preferred method of turning off the pump.

On the operation panel, push the **EMERGENCY STOP** button.

- The control circuit turns off, which turns off the pump, the primary motor, and the intensifier.
- The bleed-down valve opens to release high-pressure water from the system.
- After a short period, the low-pressure water valve opens to release low-pressure water from the system. This period is user-adjustable. Refer to **Stop-procedure Timers** on page 221.
- The CONTROLS ON button indicator light turns off.

The **EMERGENCY STOP** button must be reset before the equipment can be turned on. Turn the button clockwise until it releases.

Typical

On the operator interface, touch the STOP symbol.

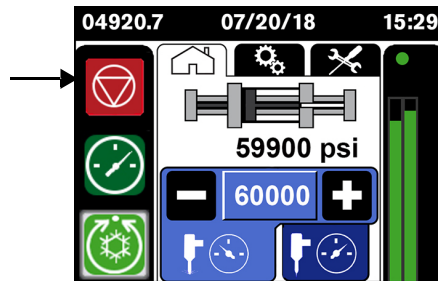

- The bleed-down valve opens to release high-pressure water from the system.
- After a short period, the low-pressure water valve opens to release low-pressure water from the system. This period is user-adjustable. Refer to **Stop-procedure Timers** on page 221.

End of day

1. Turn the primary breaker disconnect lever on the electrical enclosure door to OFF.
2. Turn OFF the water to the pump.
3. Clean all debris, water, and hydraulic fluid off of the top and bottom decks.

Section 5













Preventive maintenance

In this section





- Safety
- Benefits of preventive maintenance
- Training
- Tools
- Preventive maintenance schedule
- Instructions for how to clean, repair, and replace pump components, intensifier components, and bleed-down valve components
- Operator interface: Maintenance screens
- Prepare for storage
- Recycling and end of product life

i	Images in this manual are for reference purposes. It is possible that your product is not shown accurately.
	This section assumes that the user is familiar with the Safety, Operation, and Pump specifications sections of this manual.
	Keep accurate maintenance records. Records can help with predicting and preventing maintenance problems. Use the maintenance log feature to record maintenance performed on the pump and the intensifier. Refer to Record maintenance on page 129 for instructions.
	It is possible that not all of the information in this section applies to all pump models.

Safety

	<p>Refer to the instruction manual. Read and understand all of the safety guidelines in this manual.</p>
 DANGER	<p>A waterjet is a cutting tool. Keep away from high-pressure streams and leaks. Pressurized fluid can cause injuries.</p> <p>A high-pressure injection injury is a surgical emergency. Get medical treatment immediately for all high-pressure waterjet injuries.</p> <p>Delayed treatment can cause injuries or death. Abrasive waterjets eject a mixture of water and abrasive materials that can be injected into body tissues, leading to a dangerous infection.</p>
 DANGER	<p>Doing work on this equipment while it is energized is dangerous.</p> <p>Personnel who maintain and repair this equipment can be injured or killed if dangerous energy is not controlled. Injuries can include burns, cuts, fractures, or electrocution.</p> <p>Before opening the electrical enclosure or doing maintenance or repairs on this equipment, turn off the electrical power and release water pressure and hydraulic pressure from the system.</p> <p>Use standard lock out–tag out procedures. Isolate all sources of electrical, mechanical, hydraulic, pneumatic, chemical, thermal, or other energy with a lockable energy-isolating device that satisfies national and local requirements.</p> <p>All work that requires opening the electrical enclosure or removing covers or panels from this equipment must be done only by an approved technician.</p>
 DANGER	<p>A person who works on deenergized machinery can be injured or killed if the machinery is energized without permission.</p> <p>All personnel in an area where energy-control procedures are used must receive training for energy-control procedures.</p>
 DANGER	<p>Do not stand in line with high-pressure fittings when operating this equipment. If a high-pressure fitting fails, it can cause a stream of water or hydraulic fluid to eject from the system with force.</p>
 WARNING	<p>Personal protective equipment is recommended. If you do not use personal protective equipment, there is a risk of injury or death.</p>
 WARNING	<p>Permit only approved personnel to operate, maintain, and repair this machinery.</p>
 WARNING	<p>Release all high-pressure water before doing work on this equipment.</p>
 WARNING	<p>When work must be done in a small space or an area with limited access, the access must not be blocked by ventilation ducts, hoses, pipes, or other equipment.</p>
 WARNING	<p>Do not operate the pump without the shaft access cover and all other safety devices correctly installed.</p>
 WARNING	<p>Make sure that all connections, fasteners, locking devices, hoses, and fittings are tight before operation.</p>
 WARNING	<p>Do not block or remove warnings, cautions, or instructions.</p>

5 – Preventive maintenance

 CAUTION	<p>Do not touch a hot surface.</p> <p>Water leaking from a high-pressure fitting or the bleed-down valve can be hot.</p>
	<p>All installation, repairs, and maintenance of the electrical and plumbing systems must obey national and local codes. This work should be done only by an approved technician.</p> <p>It is the buyer's responsibility to investigate and obey all local codes.</p>
	<p>Obey all safety requirements and applicable safety laws and regulations.</p>
	<p>Examine and clean the equipment regularly.</p> <p>Refer to the Preventive maintenance schedule on page 73.</p> <p>Do repairs immediately.</p>
	<p>Obey local protocols for recycling or disposal of parts, materials, and fluids. National and local environmental rules can apply to disposal.</p> <p>Refer to Recycling and end of product life on page 136.</p>

Benefits of preventive maintenance

Hypertherm recommends preventive and scheduled maintenance for HyPrecision pumps. High-quality equipment that is maintained on a schedule lasts longer than equipment that is not maintained regularly. This maintenance includes adjustments, cleaning, lubrication, repairs, and replacement of parts.



- Improves reliability
- Finds possible problems before they cause unplanned downtime and become expensive repairs
- Extends the life of equipment and decreases the frequency of replacement
- Contributes positively to reputation and profits
- Gives traceability through records

Training

The employer must provide training for maintenance procedures. Retrain personnel when:

- there is a change in job assignment, machinery, or processes that can present a new danger.
- energy-control procedures change.
- there is reason to believe there is a deficiency in a person's knowledge of the energy-control procedure.

Tools

	Use the correct tools for maintenance procedures. Some tools are designed to make the procedure easier and to prevent damage to the equipment.
	Personnel who maintain and repair this equipment must know how to use standard hand tools.
	Use SAE tools for most procedures.

Special tools are recommended or necessary for some maintenance and repair procedures. This page is intended to help a user identify tools that are unfamiliar or are known by other names.



Open-ended wrench



Crowfoot wrench



Screwdriver



Standard



Phillips



O-ring pick



Seal housing removal tool (included in the 1-12084 HyPrecision standard tool kit)

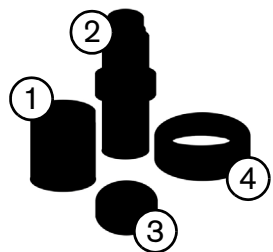

Seal installation tools (included in the 1-12084 HyPrecision standard tool kit)

- | | |
|--------------------|------------------|
| 1 Sleeve | 3 Spacer |
| 2 Push tool | 4 Locator |

Preventive maintenance schedule

 WARNING	Repair or replace parts identified in the preventive maintenance schedule or if the parts show deterioration, corrosion, or damage.
---	---

These maintenance intervals are general guidelines.

The top left of the operator interface screen shows the total hours the pump has been in operation.

	Every work shift	Every 500 hours	Every 1,000 hours	Every 1,500 hours	Every 3,000 hours	Every 6,000 hours
General (refer to page 76)						
Examine and clean the equipment.	✓					
Examine the pump for leaks or damage.						
Electrical system (refer to page 79)						
Make sure that the emergency stop operates correctly.						
Make sure that the electrical interlock operates correctly.	✓					
Examine cords, plugs, and cables.						
Hydraulic system (refer to page 81)						
Check the hydraulic filter.						
Check the hydraulic fluid level.	✓					
Check the hydraulic fluid quality.						
Replace the hydraulic filter.				✓		
Replace the hydraulic fluid.					✓	
Lubricate the primary motor bearings.						✓

Preventive maintenance





5 – Preventive maintenance

	Every work shift	Every 500 hours	Every 1,000 hours	Every 1,500 hours	Every 3,000 hours	Every 6,000 hours
Low-pressure water system (refer to page 89)						
Check the low-pressure water pressure gauges.	✓					
Clean the Seal Maintenance Indicator tubes. Measure the air pressure in the water accumulator tank.		✓				
Replace the water filters. Test the low-pressure water TDS level.			✓			
Replace the Seal Maintenance Indicator tubes.				✓		

5 – Preventive maintenance

	Every 500 hours	Every 1,000 hours	Every 2,000 hours	Every 3,000 hours	Every 6,000 hours	Every 12,000 hours
High-pressure water system: Intensifier (refer to page 97)						
Disassembling the intensifier is necessary for some of these procedures (page 99). To reduce downtime, Hypertherm recommends doing preventive maintenance on both ends of the intensifier at the same time.						
Repair the check valves and the low-pressure poppets. Install the high-pressure hoops, the high-pressure water seals, the high-pressure cylinders, and the check valves. Replace the hydraulic rod seals. Repair the high-pressure cylinders.	✓					
Replace the high-pressure poppet assemblies. Replace the low-pressure poppets and the poppet springs.		✓				
Replace the check valve assemblies. Replace the low-pressure poppet baskets.			✓			
Replace the high-pressure cylinders. Replace the plunger bearings. Replace the indicator pin springs.				✓		
Replace the output adapters. Replace the seal housing assemblies					✓	
Replace the spacer tubes. Repair the hydraulic center section.						✓
High-pressure water system: Bleed-down valve (refer to page 122)						
Repair the bleed-down valve.		✓				
Replace the bleed-down valve body.				✓		

General

 WARNING	Repair or replace parts identified in the preventive maintenance schedule or if the parts show deterioration, corrosion, or damage.
	Hydraulic, water, and electrical connections can become loose during shipping and normal operation. We recommend examining all connections at installation and during regular maintenance.
	Identify the source of a leak and correct the problem. Refer to Leaks on page 163. A leak can cause damage to the water fittings.
	When replacing wiring, use only the same size, type, and color as the original wiring.
i	Coordinate maintenance and repairs with facility and safety staff.
	Keep the work area clean and dry. Clean fluid spills immediately. Use catch basins under areas where water or hydraulic fluid can spill during maintenance or repair procedures.
	Keep spare parts and repair kits available.
	Some referenced parts are included in kits. Refer to the Parts lists section, which starts on page 137 for information.
	Keep the work area clean and dry. Clean fluid spills immediately. Use catch basins under areas where water or hydraulic fluid can spill during maintenance or repair procedures.

Examine and clean the equipment

Do this every work shift.

1. Check the dirty water container.

	Refer to local regulations regarding waste water. Environmental rules can apply to disposal.
i	Water in the container could have oil in it.

Empty the container, if necessary

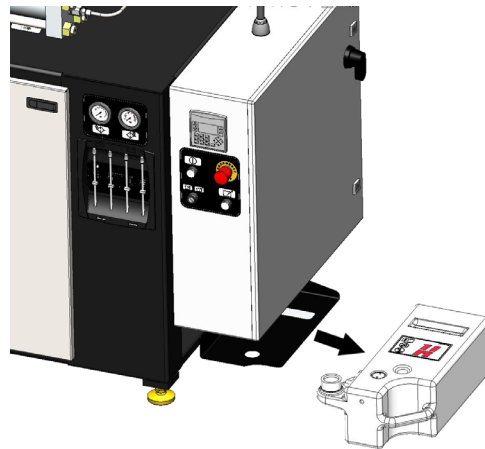

5 – Preventive maintenance

2. Make sure that the drip tray is empty and clean.

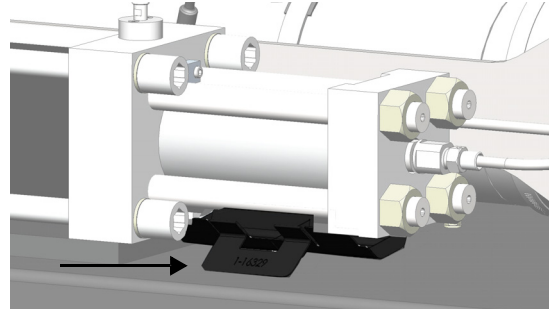
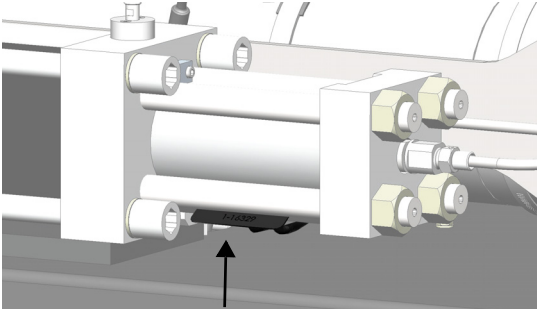

To remove the tray, push down on the tab until the tray releases. Pull the tray toward you.



Do not pull the tray out fully. There are 2 tubes attached to the rear of the tray that must be disconnected first.

To install the tray, put the rear edge of the tray between the stud and the high-pressure cylinder. Push up on the tray tab until the tray makes a click.

3. Make sure that all warning decals are visible and legible.

Contact Hypertherm for replacement decals.

4. Clean the operator interface, if necessary.



To prevent damage to the operator interface:

- Do not use cleaners that contain alcohol, ammonia, acetone, phosphates, or ethylene glycol.
- Do not push hard on the touchscreen.
- Do not use paper towels, abrasive cloth, or dirty rags.
- Do not put liquid directly onto the touchscreen.
- Do not scratch the surface.

- Gently wipe the touchscreen and keys with a clean microfiber cloth.
- Use a cleaner made for touchscreens or use a 1:1 solution of distilled water and white vinegar.

5. Clean the transparent panels on the top cover, if necessary. (For HyPrecision P-50S/P-60S/P-75S pumps)

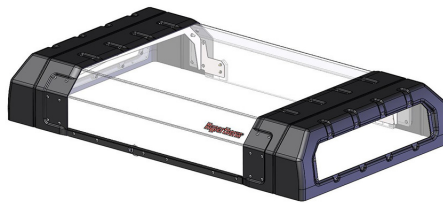

- a. Use a clean microfiber cloth with a cleaner made for acrylic or a solution of clean water and mild dish soap. Gently dab the surface.
- b. After wiping the entire panel, use a dry section of the microfiber cloth to dry and buff the plastic.
- c. Do this procedure again until the panel is clean



To prevent damage to the transparent panels:

- Do not use cleaners that contain alcohol, ammonia, or acetone.
- Do not use paper towels, abrasive cloth, or dirty rags.
- Do not scratch the surface.

6. Examine the Seal Maintenance Indicator (SMI) tubes for leaks and debris. To clean the tubes, refer to **Clean the Seal Maintenance Indicator tubes** on page 89.

5 – Preventive maintenance

Examine the pump for leaks or damage

Do this every work shift.

Do this task when the pump is running and the system is pressurized.

1. Look for hydraulic fluid leaks. Monitor these areas:
 - Hydraulic fluid tank access cover
 - Hydraulic connections
 - Valves
 - Top and bottom pump decks
2. Examine the low-pressure tubes and the hoses for leaks.
3. Examine the bleed-down valve for leaks or damage.
4. Examine the weep holes in the high-pressure ends for leaks. Water leaking from a weep hole is a sign of a faulty part or a loose connection.

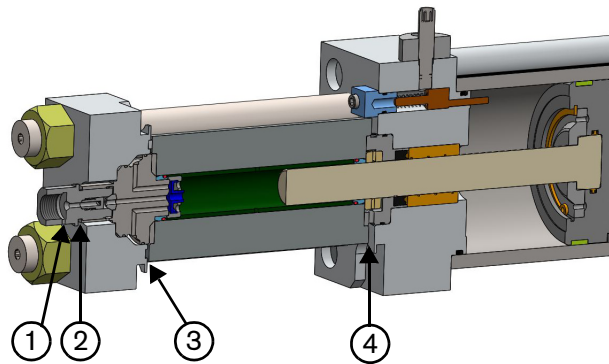

- | | | | |
|---|-------------------------|---|-------------------|
| 1 | Output adapter leak | 3 | Static seal leak |
| 2 | High-pressure seat leak | 4 | Dynamic seal leak |

The SMI monitors the rate of drops from the static seal and the dynamic seal.

5. Examine the high-pressure tubing for leaks.
6. Look for deterioration, damage, or other conditions that can interfere with operation.

Electrical system

Make sure that the emergency stop operates correctly

Do this every work shift.

The **EMERGENCY STOP** button is found on the operation panel.



Do this task when the pump is running.

Refer to **Stop the pump** on page 67.

Make sure that the electrical interlock operates correctly

Do this every work shift.

The electrical interlock is optional on all models with top covers.

Do this task when the pump is running.

Open the top cover.

The result is the same as described for when the **EMERGENCY STOP** button is pushed. Refer to **Stop the pump** on page 67.

5 – Preventive maintenance

Examine cords, plugs, and cables

Do this every work shift.

Do this task when the pump is not running.

1. Examine electrical cords and cables for kinks or damage to the insulation.
2. Examine electrical plugs and other electrical connections for corrosion or damage.
3. Make sure that the SMI cable harness is not damaged and that the connections are not loose.

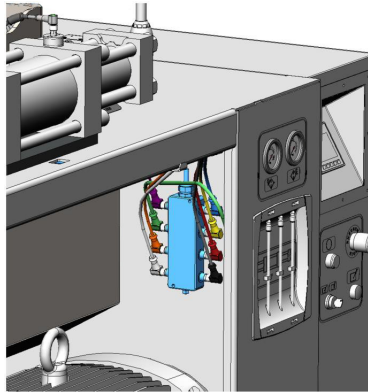

The cable harness connects to the junction box (shown) and to the rear of the SMI.

Hydraulic system

Check the hydraulic filter

Do this every work shift.

Replace the hydraulic filter:

- Every 1,500 hours
- When the white indicator bar stays in the red zone while the pump is at operating temperature

Refer to **Replace the hydraulic filter** on page 83 for instructions.

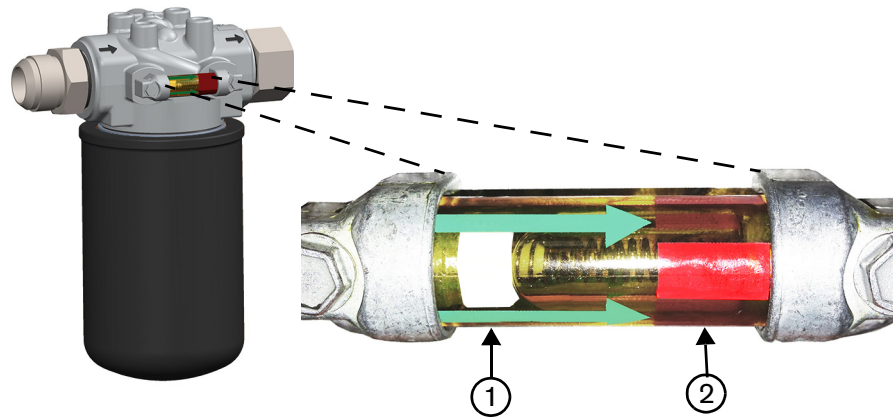

1 White indicator bar

2 Red zone



Parts, tools, and materials

Standard screwdriver

Do this task when the pump is running at operating temperature.

Use a standard screwdriver to remove the pump cover.

Make sure that the white indicator bar is not in the red zone.

5 – Preventive maintenance

Check the hydraulic fluid level

Do this every work shift.

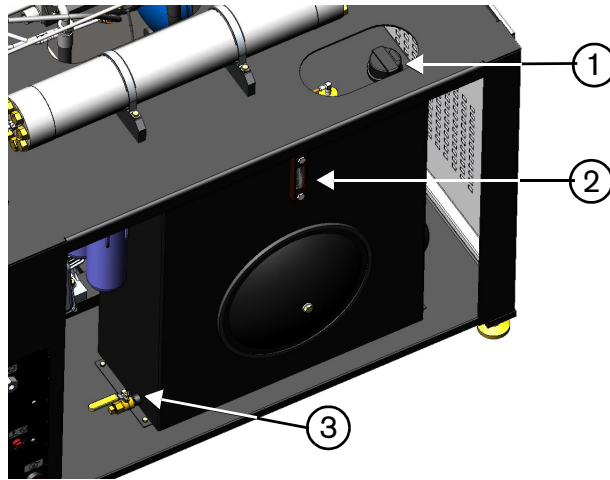

1 Filler-breather cap

2 Sight gauge

3 Drain valve



Parts, tools, and materials

Standard screwdriver

Do this task when the pump is running.

Use a standard screwdriver to remove the pump cover.

Make sure that the hydraulic fluid level is at the top mark on the sight gauge. Add hydraulic fluid, if necessary.

Add hydraulic fluid



Do not put too much hydraulic fluid in the tank.

The capacity of the hydraulic fluid tank is 150 L (40 gallons).



Parts, tools, and materials

Antiwear (AW) mineral oil or synthetic hydraulic fluid, ISO viscosity grade (VG) 32 or 46

Recommended materials

Clean funnel

Do this task when the pump is not running.

1. Make sure that the drain valve is closed.
2. Remove the filler-breather cap on top of the tank.
3. Fill the tank with hydraulic fluid until the fluid is at the top mark on the sight gauge.
4. Install the filler-breather cap.

Check the hydraulic fluid quality

Do this every work shift.

Replace the hydraulic fluid:

- If it is dark or milky in color
- If it has a strong odor
- After every 3,000 hours of operation



Contact a hydraulic fluid supplier for a precise report about your hydraulic fluid quality.

Do this task when the pump is not running.

1. Make sure that the drain valve is closed.
2. Look through the sight gauge to see the color of the hydraulic fluid. Good hydraulic fluid is almost transparent.
3. Remove the filler-breather cap on top of the tank.
4. Smell the hydraulic fluid. Good hydraulic fluid has almost no odor.

Replace the hydraulic filter

Replace the hydraulic filter:

- Every 1,500 hours
- When the white indicator bar stays in the red zone while the pump is at operating temperature

Refer to **Replace the hydraulic filter** on page 83 for instructions.



Parts, tools, and materials

1-16025 Hydraulic filter
(1-17473 Hydraulic fluid service kit includes 2)

Antiwear (AW) mineral oil or synthetic hydraulic fluid, ISO viscosity grade (VG) 32 or 46

Strap wrench

Do this task when the pump is not running.

1. Remove the used filter from the filter head.
2. Put clean hydraulic fluid on the gasket on the new filter.
3. Twist the filter onto the filter head.
4. Tighten the filter with a strap wrench.
5. Turn ON the pump in cooling mode.
6. Monitor for leaks.
7. Check the hydraulic fluid level. Add hydraulic fluid, if necessary. Refer to page 82 for instructions.

5 – Preventive maintenance

Replace the hydraulic fluid

Do this every 3,000 hours.

Install a new hydraulic filter and filler-breather cap when replacing the hydraulic fluid.



Do not put too much hydraulic fluid in the tank.

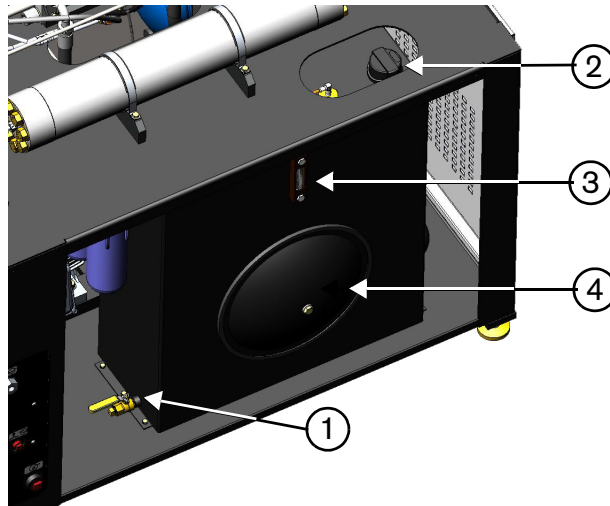

- | | |
|-------------------------------|-------------------------------------|
| 1 Drain valve | 4 Access cover |
| 2 1-14629 Filler-breather cap | 1-16025 Hydraulic filter, not shown |
| 3 Sight gauge | |



Parts, tools, and materials

- | | |
|---|---|
| 1-17473 Hydraulic fluid service kit | Torque wrench |
| Antiwear (AW) mineral oil or synthetic hydraulic fluid, ISO viscosity grade (VG) 32 or 46 | Strap wrench |
| Clean towels | Hose or pipe for draining hydraulic fluid |
| Isopropyl alcohol | Container for used hydraulic fluid |
| Standard 9/16-inch open-ended wrench (for the drain valve plug) | |
| Standard 15/16-inch crowfoot wrench or socket (for the access cover) | Recommended materials |
| | Clean funnel |

Do this task when the pump is not running.

5 – Preventive maintenance

1. Remove the drain valve plug.
2. Open the drain valve lever on the bottom of the hydraulic fluid tank. Use a hose or a pipe to direct the hydraulic fluid into a container.

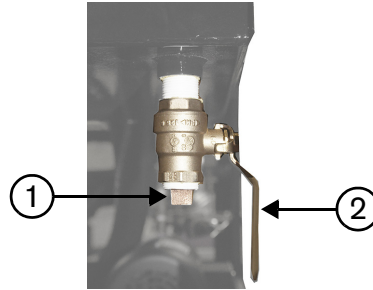

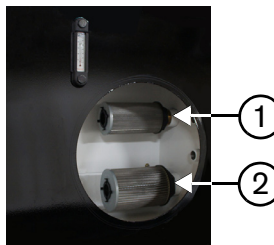

- 1 Drain valve plug
- 2 Drain valve lever

3. Disconnect the lower ends of the hydraulic hoses to drain them.
4. Install a new hydraulic filter. Refer to **Replace the hydraulic filter** on page 83 for instructions.
5. Remove the access cover on the tank.
6. Use a strap wrench to remove the suction strainers in the tank.



- 1 1-12438 Suction strainer, 1-1/2 inch (to the gear pump)
- 2 1-11960 Suction strainer, 2-1/2 inch (to the hydraulic pump)

7. Clean the inner surfaces of the tank with towels and isopropyl alcohol. Make sure that no debris is left in the bottom of the tank.

 CAUTION	Remove all towels from the tank before putting hydraulic fluid in it.
	Do not use soap, detergent, or solvents.

8. Install new suction strainers.
Tighten the suction strainer by hand and then turn it 90° more.
9. Close the drain valve.
10. Install a drain valve plug.
11. Install a new crush washer.
12. Install a new access cover gasket.
13. Replace the access cover on the tank. Torque the nut to 27 N·m (20 lbf·ft).
14. Remove the used filler-breather cap.

5 – Preventive maintenance

15. Fill the tank with hydraulic fluid until the fluid is at the top mark on the sight gauge.
16. Install a new filler-breather cap.
17. Discard the used parts.
18. Turn ON the pump in cooling mode. Let it operate for 15 to 20 minutes.
19. Monitor for leaks.
20. Add hydraulic fluid, if necessary. Do the procedure again, if necessary.
21. Operate the pump in pierce-pressure mode for 15 to 20 minutes.

If air is in the hydraulic system, the pump can be noisy during operation. Refer to **The pump makes noise during operation** on page 174.

Lubricate the primary motor bearings

Do this every 6,000 hours.



Parts, tools, and materials

Low-pressure handheld grease gun
NLGI grade 2 bearing grease

Recommended greases

Exxon Polyrex™ EM
(motors are lubricated with this grease at the factory)

Exxon Unirex™ N 2

Exxon Mobilith SHC™ 100

Chevron SRI

Shell Dolium R

Do this task when the pump is running.

1. Remove a relief plug from the bottom of the motor.



2. Make sure that the grease fittings are clean.

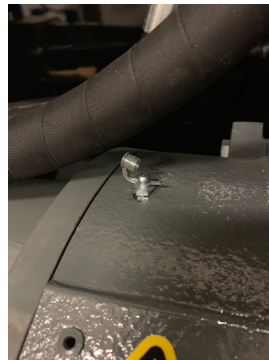
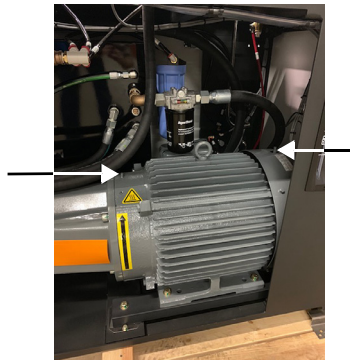

3. Attach the grease gun coupler to the grease fitting on the same end of the motor as the open relief plug.

5 – Preventive maintenance

- Use the grease gun to put the specified quantity of grease in the motor.

i	The grease gun should deliver approximately 1.25 grams of grease for each pump or 5 grams for every 4 pumps. The manufacturer can give you the pump volume.
----------	---

HyPrecision P-15	HyPrecision P-30 HyPrecision P-50 HyPrecision P-50S	HyPrecision P-60S HyPrecision P-75S
20 grams	30 grams	40 grams

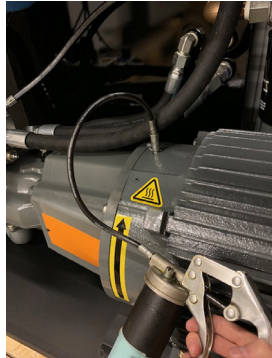

- Let the motor operate with the grease outlets open for 20 to 30 minutes.
- Clean grease from the outside of the grease outlet and replace the relief plug.

i	It is possible that used grease does not come out of the grease outlet when the new grease is pumped in. Use only the recommended volume.
----------	---

- Do this procedure again on the other end of the motor.

5 – Preventive maintenance

Low-pressure water system

Examine the transport tubes

Do this every 500 hours and when the high-pressure seals are replaced.

Make sure that the transport tube routing is correct.



Good tube routing



Bad tube routing

Clean the Seal Maintenance Indicator tubes

Do this every 500 hours and when the high-pressure seals are replaced.

Replace the tubes every 1,500 hours.

The inner surfaces of the SMI tubes become dirty over time. Dirty tubes can cause a fluid monitoring sensor error.



Parts, tools, and materials

1-17520 SMI tube cleaning brush
(included in the 1-12084 HyPrecision standard
tool kit)

Do this task when the pump is off.

5 – Preventive maintenance

1. Disconnect a tube by pulling the tube away from the clip.



2. Disconnect the tube from the push-to-connect fitting on top of the SMI by pushing up on the collar of the fitting while pulling down on the tube.



3. Use the tube cleaning brush to clean the inner surfaces of the tube.

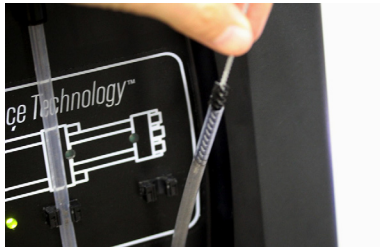

Before cleaning

After cleaning

4. Rinse the tube with clean water.
5. Connect the tube to the push-to-connect fitting on top of the SMI.
6. Push the tube into the clip.
7. Do this procedure for all 4 tubes.

Replace the Seal Maintenance Indicator tubes

Do this every 1,500 hours.

The inner surfaces of the SMI tubes become dirty over time. Dirty tubes can cause a fluid monitoring sensor error.



Parts, tools, and materials

1-17501 Seal Maintenance Indicator tubes
replacement kit, HyPrecision P-15/P-30/P-50

or

1-17483 Seal Maintenance Indicator tubes
replacement kit, HyPrecision P-50S/P-60S/P-75S

Do this task when the pump is off.

1. Do steps 1 and 2 on page 90 to remove the tubes.
2. Do steps 5 and 6 on page page 90 to install the new tubes.

5 – Preventive maintenance

Measure the air pressure in the water accumulator tank

Do this every 500 hours.



Parts, tools, and materials

Air pressure gauge (Schrader valve)

Compressed air source

Do this task when the pump is off.

1. Make sure that the water pressure gauges show 0.0 bar (0 kPa / 0 psi).
2. Remove the valve stem cap from the water accumulator tank.

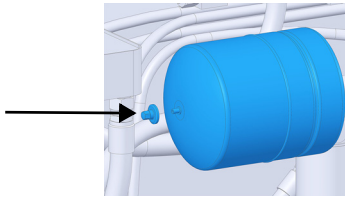

3. Use an air pressure gauge to measure the pressure in the tank.

	Optimal pressure
HyPrecision P-15/P-30/P-50	1 bar (100 kPa / 15 psi)
HyPrecision P-50S/P-60S/P-75S	3.5 bar (350 kPa / 50 psi)

4. Add compressed air to increase the pressure in the tank. To reduce pressure in the tank, push on the valve stem to release air.
5. Do this procedure again until the pressure is at the correct value.
6. Install the valve stem cap.

5 – Preventive maintenance

Check the low-pressure water pressure gauges

Replace the water filters after every 1,000 hours of operation or if the difference between the values on the prefilter water-pressure gauge and the postfilter water-pressure gauge is lower than 0.7 bar (70 kPa / 10 psi).

The prefilter water-pressure gauge shows the water pressure before the water goes through the filters. The postfilter water-pressure gauge shows the water pressure after the water goes through the filters.

The usual operating range is 2.8 bar to 7.6 bar (280 kPa to 760 kPa / 40 psi to 110 psi).

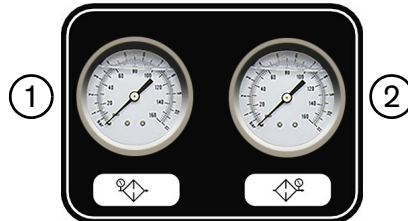

- 1 Prefilter water-pressure gauge
- 2 Postfilter water-pressure gauge

Do this task when the pump is running

Subtract the value shown on the postfilter water pressure from the value shown on the prefilter water pressure.

Replace the water filters if the difference between the values on the prefilter water-pressure gauge and the postfilter water-pressure gauge is lower than 0.7 bar (70 kPa / 10 psi).

Replace the water filters

Do this every 1,000 hours.



Replace all of the filters at the same time.

HyPrecision P-50S/P-60S/P-75S pumps have 3 filters. HyPrecision P-15/P-30/P-50 pumps have 2 filters.



Parts, tools, and materials

1-15470 Water filter cartridge, 0.22 micron, 10 inch

1-11106 Water filter cartridge, 1.0 micron, 10 inch

1-11107 Water filter cartridge, 10 micron, 10 inch
(HyPrecision P-50S/P-60S/P-75S pumps only)

Filter wrench
(included in the 11-12084 HyPrecision standard tool kit)

Recommended materials

Bucket or pail

Do this task when the pump is not running.

5 – Preventive maintenance

1. Turn OFF the water to the pump.
2. Use a filter wrench to loosen each of the filter canisters.
3. Make sure that the filter canisters are empty.
4. Remove the used filter cartridges from the filter canisters.
5. Put a new 0.22-micron filter cartridge in the housing with the plug at the bottom and the gray rubber gasket at the top.
6. Put a new filter cartridge in the 1-micron filter canister and the 10-micron filter canister.
The 1-micron and the 10-micron filters do not have a designated top or bottom.



7. Install the filters and the housings with the 10-micron water filter nearest the rear of the pump.



- 1 10-micron water filter
- 2 1-micron water filter

- 3 0.22-micron water filter

8. Discard the used parts.
9. Use a filter wrench to tighten each of the filter canisters.
10. Close the water valve.
11. Turn ON the water to the pump.
12. Turn ON the pump in cooling mode.

5 – Preventive maintenance

13. Push the water filter purge buttons until water comes out from under each button.

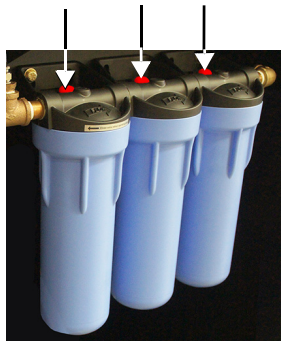

14. On the operator interface, touch the RUN symbol.
15. Make sure that the difference between the values on the prefilter water-pressure gauge and the postfilter water-pressure gauge is lower than 0.7 bar (70 kPa / 10 psi).
16. Monitor for leaks.

Test the low-pressure water TDS level

Do this every 1,000 hours.

	<p>A TDS level that is lower than 0.005% (50 ppm) can harm waterjet parts and requires the use of nonmetallic or stainless steel fittings.</p> <p>A TDS value of lower than 0.0005% (5 ppm) can damage stainless steel parts.</p>
	<p>If a water line, a fitting, or a valve could be frozen, do not operate the pump. Thaw the equipment until water moves easily through the water circuit.</p>
	<p>Treat water with a TDS level that is higher than 0.015% (150 ppm) with reverse osmosis.</p>

Some TDS meters must be calibrated before use. For best results, calibrate the meter at 25.0°C (77°F). Refer to the instructions supplied with the TDS meter.

If multiple readings are taken, turn OFF the TDS meter between readings.



Parts, tools, and materials

1-13897 TDS meter
 Container for a water sample
 Clean, deionized water or filtered water

Recommended materials

Bucket or pail

Do this task when the pump is off.

1. Remove a water supply tube from the intensifier.



When a low-pressure fitting is disconnected, water could spray from the fitting.

2. Turn ON the pump in cooling mode.
3. Take a sample of the water from the supply tube. Make sure that the water is clear and odorless.
4. Install the water supply tube.

5 – Preventive maintenance

- Put the TDS meter in the water sample up to the maximum immersion level (5 cm/2 inches). Tap the meter gently to release air bubbles.

 CAUTION	The meter is not waterproof. Do not submerge the unit in water.
---	---

Wait approximately 20 seconds for the reading to become stable.

- Compare the reading to the TDS table. The optimal range is 0.005% to 0.015% (50 ppm to 150 ppm).

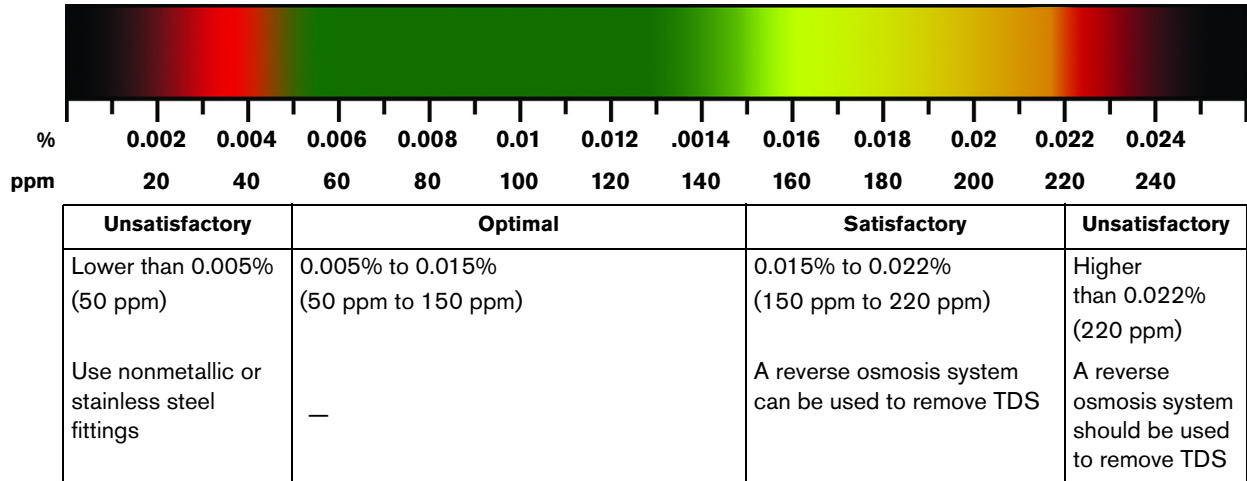

- Rinse the meter in clean, deionized water or filtered water after use.

High-pressure water system: Intensifier

To do preventive maintenance on the intensifier, you must have access to intensifier assemblies at specified intervals.

To reduce downtime, Hypertherm recommends doing preventive maintenance on both ends of the intensifier at the same time.

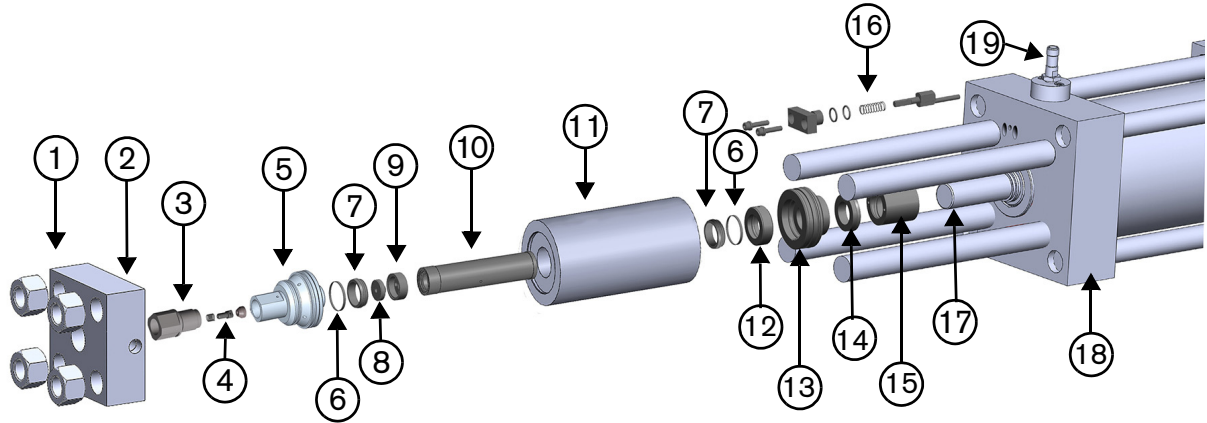

- 1** 1-11529 High-pressure end cap
1-11672 High-pressure end cap nut (4)
 - 2** 1-17410 High-pressure end cap gasket, not visible
- Refer to page 118.

- 3** 1-11530 Output adapter
 - 4** High-pressure poppet assembly
 - 1-11126 High-pressure poppet spring
 - 1-11015 High-pressure poppet seat
 - 1-11014 High-pressure poppet
- Refer to page 120.



- 5** 1-11523 Check valve assembly
 - 6** 1-11018 High-pressure hoop
 - 7** 1-11024 High-pressure water seal
 - 8** for HyPrecision P-15/P-30/P-50 pumps
 - 1-14792 Low-pressure poppet
 - 1-13907 Low-pressure poppet spring, not shown
 for HyPrecision P-50S/P-60S/P-75S pumps
 - 1-11526 Low-pressure poppet
 - 9** 1-11520 Low-pressure poppet basket
 - 10** 1-11521 Spacer tube
 - 11** 1-11522 High-pressure cylinder
- Refer to page 113.

- 12** 1-11610 High-pressure seal backup (bronze)
 - 13** 1-11609 Seal housing
 - 14** 1-11090 Hydraulic rod seal, 1 inch
 - 15** 1-11608 Plunger bearing
- Refer to page 110.

- 16** Indicator pin assembly
 - 1-11518 Indicator pin
 - 1-11519 Indicator pin cap
 - 1-11669 Indicator pin spring
- Refer to page 104.

- 17** 1-11613 Plunger
- 18** 1-11529 Hydraulic end cap
- 19** 1-11670 Proximity switch

Prepare to do maintenance on the intensifier

 WARNING	<p>Use 2 wrenches when loosening or tightening a high-pressure connection to prevent causing damage or premature failure.</p> <p>Do not tighten a fitting too much. The fitting can fail.</p>
 WARNING	<p>Do not use an adjustable wrench on high-pressure fittings.</p>
	<p>Use clean hands when changing high-pressure parts.</p>



Parts, tools, and materials

13/16-inch open-ended wrench or socket
(for the high-pressure water fitting)

1-inch open-ended wrench
(for the output adapter)

1-1/16-inch open-ended wrench
(for the high-pressure water fitting)

Do this task when the pump is running in cooling mode.

1. On the operator interface, touch the maintenance symbol to open the primary maintenance screen.



2. Touch the pump maintenance symbol to open the intensifier maintenance screen.
3. Touch the applicable symbol to move the intensifier to the left or to the right.

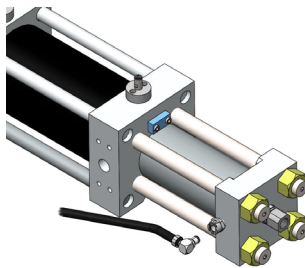

i	<p>Doing maintenance on the high-pressure end is easier when the plunger is moved to that end.</p>
----------	--

4. Turn OFF the pump.
5. Turn OFF power from the primary utility source. Use standard lock out–tag out procedures.
6. Turn OFF the water to the pump.
7. Make sure that the water pressure gauges show 0.0 bar (0 kPa / 0 psi).
8. Push the button on the quick-disconnect fitting to remove the high-pressure tubing from the intensifier.



5 – Preventive maintenance



Disassemble the intensifier

	Clean and examine parts that will be replaced to identify wear patterns or damage that can show other problems.
	Clean each part with a towel and isopropyl alcohol. Examine all parts for deterioration, corrosion, or damage. Do not use soap, detergent, or solvents.
	Put the parts on a clean, dry surface.

Refer to the **Parts lists** section, which starts on page 137.

Remove the output adapter and the high-pressure poppet assembly

Replace the high-pressure poppet assemblies every 1,000 hours.
Replace the output adapter every 6,000 hours.

	The high-pressure poppet seat can cause cracks, erosion marks, or dents in the output adapter.
	If a poppet part is damaged, replace all 3 components.

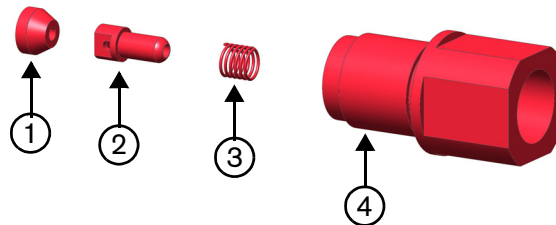

- | | |
|--|--|
| 1 1-11015 High-pressure poppet seat | 3 1-11126 High-pressure poppet spring |
| 2 1-11014 High-pressure poppet | 4 1-11530 Output adapter |



Parts, tools, and materials

Clean towels
Isopropyl alcohol
1-inch open-ended wrench
1-15564 Cotton-tipped applicator

1. Use an open-ended wrench to loosen the output adapter. Remove the output adapter from the check valve.
2. Use a cotton-tipped applicator to guide the high-pressure poppet seat out of the check valve. Tap the output adapter gently on a wooden or other soft surface to eject the poppet from the output adapter.

5 – Preventive maintenance

Remove the high-pressure end cap

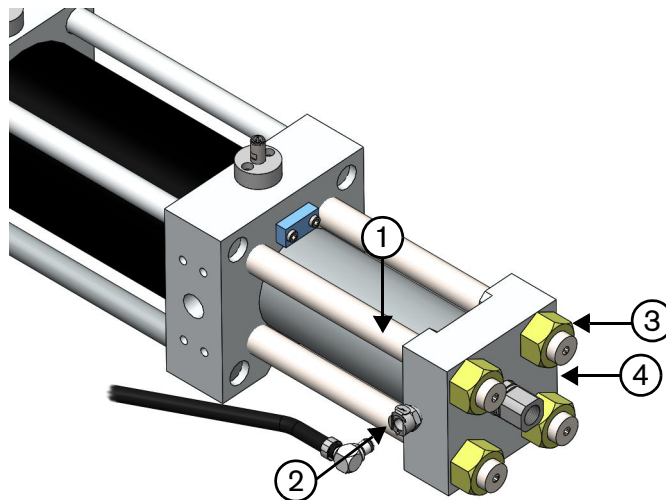

1 Stud

2 Low-pressure water fitting

3 High-pressure end cap nut

4 High-pressure end cap



Parts, tools, and materials

Clean towels

Isopropyl alcohol

Square drive socket, 1-1/2 inch × 3/4 inch
(included in the 1-12084 HyPrecision standard
tool kit)

1. Remove the end cap nuts.
2. Pull the high-pressure end cap off.
3. Remove the end cap gasket.

5 – Preventive maintenance

Remove the high-pressure cylinder assembly and the check valve assemblies

Replace the check valves every 2,000 hours.

Replace the high-pressure cylinder assemblies:

- every 3,000 hours
- if the cylinder is chipped or cracked

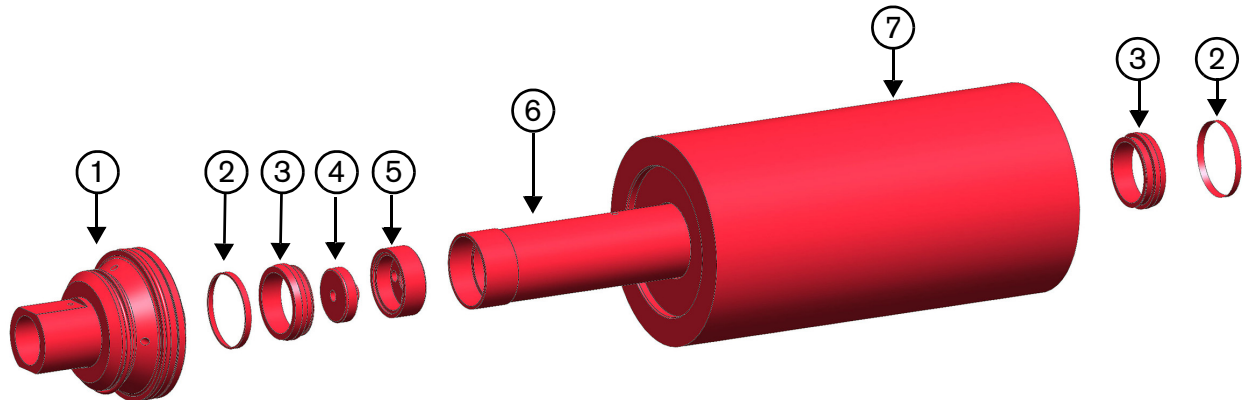

- | | | | |
|---|--|---|------------------------------------|
| 1 | 1-11523 Check valve assembly | 5 | 1-11520 Low-pressure poppet basket |
| 2 | 1-11018 High-pressure hoop | 6 | 1-11521 Spacer tube |
| 3 | 1-11024 High-pressure water seal | 7 | 1-11522 High-pressure cylinder |
| 4 | 1-14792 Low-pressure poppet
(for HyPrecision P-15/P-30/P-50 pumps)
or
1-11526 Low-pressure poppet
(for HyPrecision P-15/P-30/P-50 pumps) | | |



Parts, tools, and materials

Clean towels

Isopropyl alcohol

Seal installation tools (refer to page 72)

Rubber mallet

1. Remove the high-pressure cylinder and the check valve from the plunger.
2. Remove the check valve by rolling the cylinder and tapping the check valve with a rubber mallet. Tap at an angle away from the cylinder.
3. Tilt the cylinder so that the low-pressure poppet comes out.
4. Put the cylinder on the seal-locating ring.
5. Put the stepped end of the push tool against the seal and tap on the end of the push tool with a rubber mallet to push the bottom seal and the hoop out of the high-pressure cylinder.
6. Turn the cylinder over and put it on the locating ring.
Prevent the spacer tube from sliding out when the cylinder is turned over.
7. Put the nonstepped end of the push tool against the spacer tube and tap on the end of the push tool with a rubber mallet to push the seal and the hoop out of the high-pressure cylinder.

5 – Preventive maintenance

8. Take the spacer tube out of the cylinder.
9. Disassemble all of the parts.

Remove the plunger bearing and the seal housing assembly

Replace the plunger bearings:

- every 3,000 hours
- when replacing the high-pressure cylinder

Replace the seal housing assemblies every 6,000 hours.



Remove the proximity switch from the hydraulic end cap to make this procedure easier.

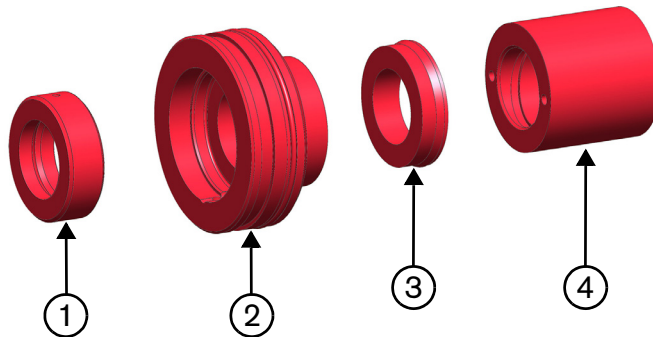
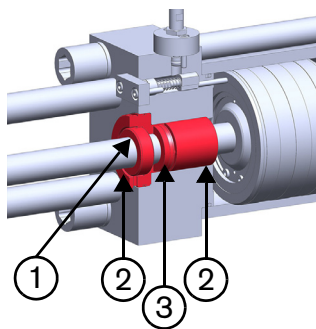

- 1 1-11610 High-pressure seal backup (bronze)
- 2 1-11609 Seal housing

- 3 1-11090 Hydraulic rod seal, 1 inch
- 4 1-11608 Plunger bearing



Parts, tools, and materials

Clean towels

Isopropyl alcohol

Two 10-32 stainless steel screws
(to remove the plunger bearing)

Seal housing removal tool

1/8-inch hex wrench
(for the seal housing removal tool)

O-ring pick (or similar tool)

1. Put the seal housing removal tool into the groove on the seal housing.

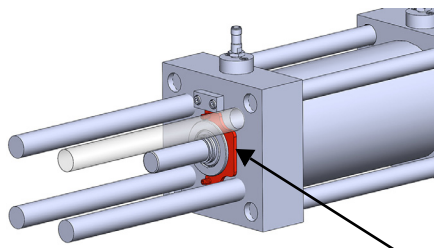

2. Use a hex wrench to turn the screws on the seal housing removal tool.

Turn the screws on one side and then the other so that the tool pulls the housing straight out of the hydraulic end cap.

5 – Preventive maintenance

3. Pull the seal housing and the high-pressure seal backup off the plunger.

i

If the rod seal does not come out of the hydraulic end cap with the seal housing, use an O-ring pick or a similar tool to pry it out. Be careful to not scratch the plunger.

4. Remove the high-pressure seal backup and the O-ring from the seal housing.
5. Install the 10-32 stainless steel screws in the threaded holes in the plunger bearing. Use the screws to pull the plunger bearing out of the hydraulic end cap.
6. Remove the plunger bearing from the plunger.

5 – Preventive maintenance

Remove the indicator pin assembly

Replace the indicator pin springs every 3,000 hours.

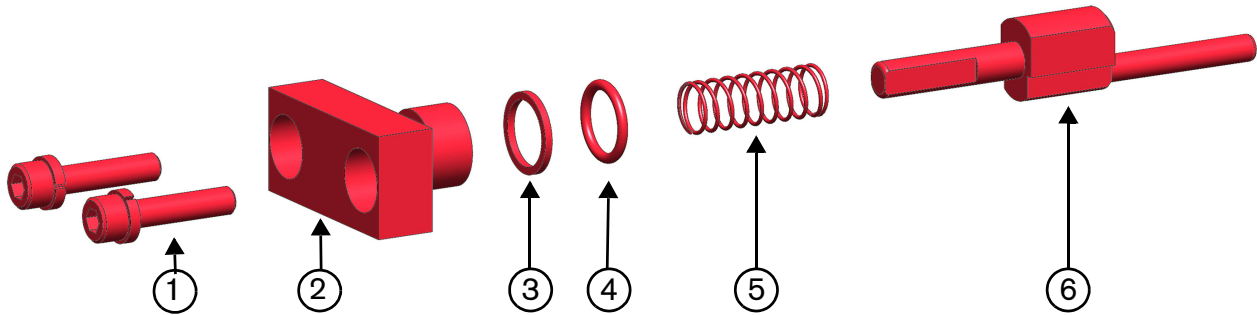

- 1 1-13663 Cap screw and
1-13665 Lock washer
- 2 1-11519 Indicator pin cap
- 3 1-11680-013 O-ring backup, -013

- 4 1-11679-013 Indicator pin O-ring, -013
- 5 1-11669 Indicator pin spring
- 6 1-11518 Indicator pin



Parts, tools, and materials

Clean towels
Isopropyl alcohol
5/32-inch hex wrench

1. Use a hex wrench to remove the socket-head cap screws and the lock washers from the indicator pin cap.
2. Pull the indicator pin cap out of the hydraulic end cap.
3. If the O-ring backup and the O-ring are being replaced, remove them from the indicator pin cap.
4. Remove the spring from the indicator pin.
5. Remove the indicator pin from the indicator pin hole in the hydraulic end cap.

5 – Preventive maintenance

Repair the check valves and the low-pressure poppets

Repair the check valves every 500 hours.

Replace the low-pressure poppets every 1,000 hours.



Do not rock the part or use too much pressure. Doing so can cause damage to the part face.

This procedure is for a moderately worn check valve. Replace very worn components.

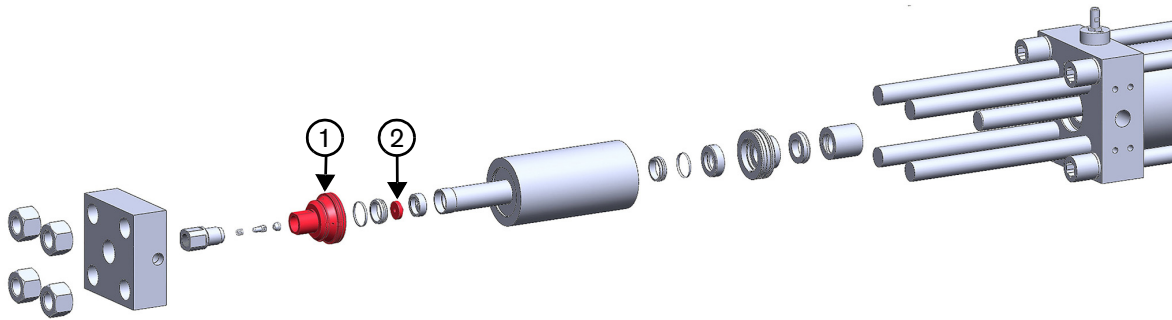

- 1 1-11523 Check valve assembly
- 2 1-14792 Low-pressure poppet
(for HyPrecision P-15/P-30/P-50 pumps)
or
1-11526 Low-pressure poppet
(for HyPrecision P-15/P-30/P-50 pumps)



Parts, tools, and materials

12-micron lapping paper
(included in the 1-12084 HyPrecision standard
tool kit)

Granite lapping block
(included in the 1-12084 HyPrecision standard
tool kit)

Masking tape

Isopropyl alcohol

Clean towels

5 – Preventive maintenance

1. Tape a sheet of lapping paper on a granite lapping block. Make sure that the paper is smooth and flat.
2. Put the check valve or poppet face flat on the lapping paper and move it back and forth. Apply light pressure.

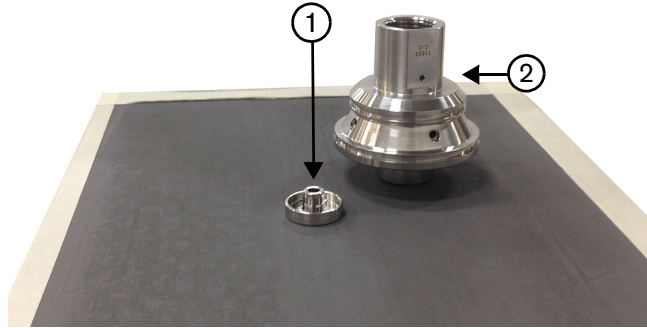

3. After each stroke, turn the flat face of the part 45°.
4. Do this procedure again until the face is smooth and flat and has an almost mirrored finish.

Repair the high-pressure cylinders

Repair the high-pressure cylinders every 500 hours.

Replace the high-pressure cylinders:

- every 3,000 hours
- if the cylinder is chipped or cracked



Debris in the cylinder can cause the seals or the poppets to fail.

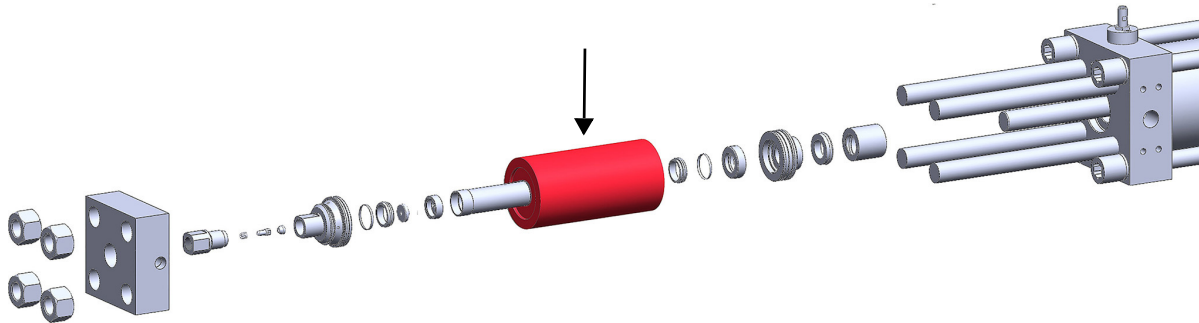

Parts, tools, and materials

- 1-11210-12 Lapping paper, 12 micron
- Clean towels
- Nonstick scouring pad
- Isopropyl alcohol
- Emery cloth (no coarser than 120 grit)

5 – Preventive maintenance



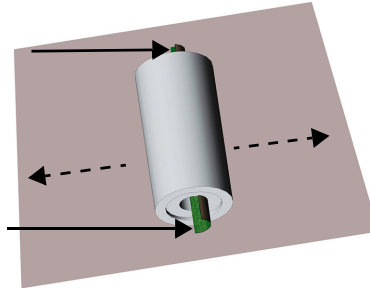



1. Put the cylinder on a flat surface.
2. Examine the end of the cylinder. If the area around the bore is marked or pitted, remove the defects with emery cloth and then with a nonstick scouring pad.
3. Examine the edges of the cylinder bore. If the bore has rough edges or burrs, remove the defects with an emery cloth.
4. Cut the nonstick scouring pad in half. Put half of the pad in each end of the cylinder. Put 1 thumb in each end of the cylinder on top of the pad and push down. Push evenly on the pad while rolling the cylinder back and forth.



Nonstick scouring pad

5. Cut 2 pieces of lapping paper, each approximately 3 cm (1-1/4 inches) wide by 8 cm (3-1/4 inches) long.
6. Put the lapping paper into the ends of the cylinder with the abrasive side touching the cylinder.
7. Do the rolling procedure again with the lapping paper.
8. Clean the inner surfaces of the cylinder with a towel and isopropyl alcohol.

Assemble the intensifier

 WARNING	Use 2 wrenches when loosening or tightening a high-pressure connection to prevent causing damage or premature failure. Do not tighten a fitting too much. The fitting can fail.
	Put the parts on a clean, dry surface.
	Before assembling high-pressure or hydraulic parts, clean the parts to remove grease and other contamination.
	Examine parts that are being replaced to identify wear patterns or damage that can show other problems.
	Clean each part with a towel and isopropyl alcohol. Examine all parts for deterioration, corrosion, or damage. Do not use soap, detergent, or solvents.
	Use clean hands when changing high-pressure parts.

 Refer to the **Parts lists** section, which starts on page 137.

Repair the hydraulic center section

Repair the hydraulic center section every 12,000 hours.

The hydraulic center section includes the piston, the plungers, the hydraulic cylinder, the hydraulic end caps, the low-pressure seals, and the proximity switches.

Preventive maintenance on these parts requires special tools. Contact a Hypertherm Technical Service Associate for information and support regarding the installation, operation, maintenance, and repair of this equipment.

5 – Preventive maintenance

Install the indicator pin assembly

Replace the indicator pin springs every 3,000 hours.

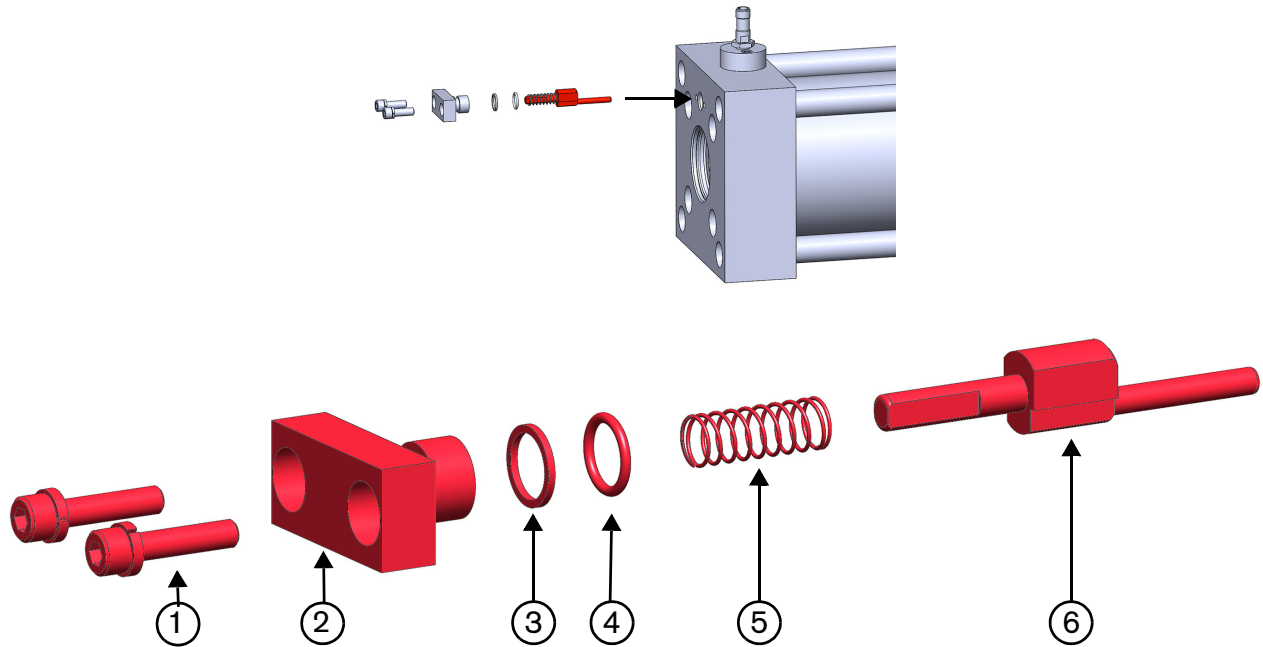

- 1 Cap screws and lock washers
- 2 1-11519 Indicator pin cap
- 3 1-11680-013 O-ring backup, -013

- 4 1-11679-013 Indicator pin O-ring, -013
- 5 1-11669 Indicator pin spring
- 6 1-11518 Indicator pin



Parts, tools, and materials

1-11518 Indicator pin
1-11669 Indicator pin spring
(included in the standard spares kit)
1-13186 Antiseize bolt lubricant
(white lithium grease)

Antiwear (AW) mineral oil or synthetic hydraulic
fluid, ISO viscosity grade (VG) 32 or 46

Torque wrench

5/32-inch hex wrench or hex-bit socket

1. Put the indicator pin into the indicator pin hole in the hydraulic end cap. Turn the pin so that the offset post goes into the opening at the back of the hole.
2. Put the spring on the indicator pin.
3. Put the O-ring backup on the indicator pin cap.
4. Put a small quantity of hydraulic fluid on the O-ring.
5. Put the O-ring on the indicator pin cap.
6. Put the indicator pin cap into the hydraulic end cap.
7. Put antiseize bolt lubricant on the cap screws.
8. Put the lock washers on the cap screws. Torque the cap screws to 11 N·m (8 lbf·ft).

5 – Preventive maintenance

Install the seal housing assembly and the plunger bearing

Replace the plunger bearings:

- every 3,000 hours
- when replacing the high-pressure cylinder

Replace the seal housing assemblies every 6,000 hours.



CAUTION

Water can enter the hydraulic system if the weep holes in the dynamic seal backup or the seal housing are blocked. Make sure that there is no debris in the weep holes.

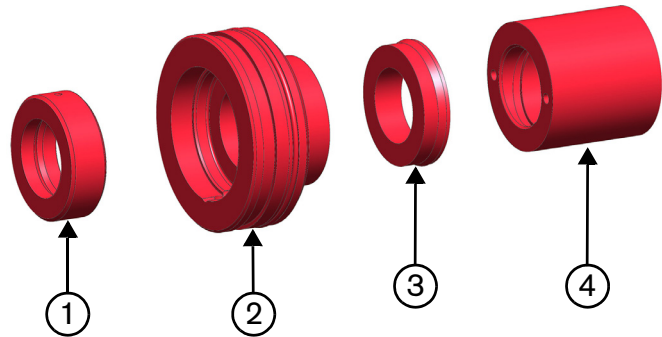
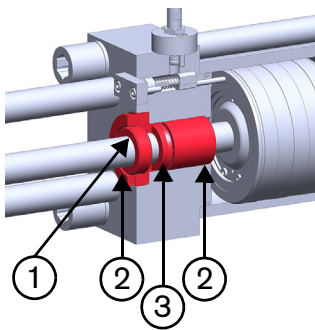

1 1-11610 High-pressure seal backup (bronze)

2 1-11609 Seal housing

3 1-11090 Hydraulic rod seal, 1 inch

4 1-11608 Plunger bearing



Parts, tools, and materials

1-17437 HyPrecision premium high-pressure seal repair kit

1-11608 Plunger bearing

1-11609 Seal housing

1-13969 Petroleum-based O-ring lubricant, 56 g (2 oz.)

Antiwear (AW) mineral oil or synthetic hydraulic fluid, ISO viscosity grade (VG) 32 or 46

1. Examine the seal housing and the high-pressure seal backup. Make sure that the weep holes and the inner grooves are clean.

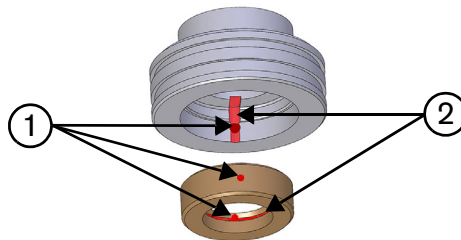

1 Weep holes

2 Grooves

2. Put O-ring lubricant on the backup ring and the seal housing O-ring.

5 – Preventive maintenance

- Put the seal housing O-ring backup and the seal housing O-ring on the seal housing. Put the O-ring on the side nearer the narrow end of the seal housing.

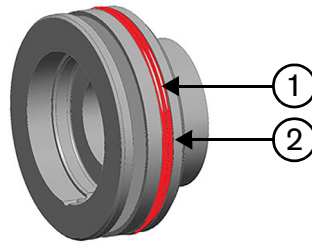

- 1-11680-035 O-ring backup, -035
- 1-11679-011 Seal housing O-ring, -011

 The seal housing O-ring backup has a flat side and a concave side. Make sure the flat side of the O-ring backup faces the wide end of the seal housing. The O-ring fits into the concave groove on the O-ring backup.

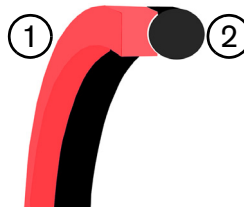

- Put the plunger bearing on the plunger. Push the plunger bearing into the hydraulic end cap.

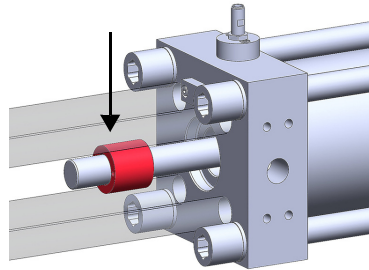

- Put a small quantity of clean hydraulic fluid on the inner and the outer surfaces of the rod seal.
- Put the rod seal onto the plunger with the wider side toward the hydraulic end cap.

 Do not push the rod seal into the hydraulic end cap.

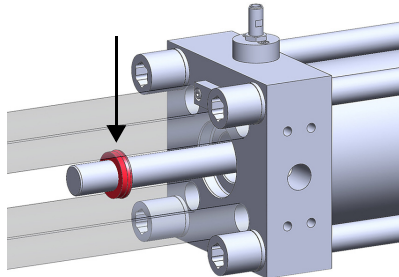

- Put hydraulic fluid in the narrow end of the seal housing.
- Put the seal housing on the plunger with the narrow end toward the hydraulic end cap.
- Push the rod seal into the seal housing.
- Turn the seal housing so that the weep hole faces down.

5 – Preventive maintenance

11. Push the seal housing tightly against the plunger bearing.
12. Turn the high-pressure seal backup so that 1 weep hole is in line with the seal housing weep hole.
13. Put the high-pressure seal backup on the plunger and push it against the seal housing.
14. Make sure that the bottom weep holes are aligned.

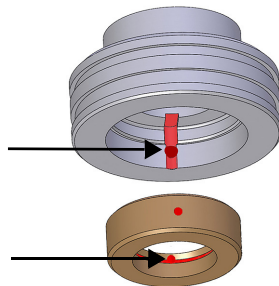

15. If the proximity switch was removed for this procedure, reinstall it.

5 – Preventive maintenance

Install the high-pressure hoops, the high-pressure water seals, the high-pressure cylinders, and the check valves



Do not put grease or lubricant on the check valve face or in the cylinder bore. These components are designed for dry contact.

Repair the high-pressure cylinders and the check valves every 500 hours.

Repair the high-pressure hoops and the high-pressure water seals every 500 hours.

Replace the check valves every 2,000 hours.

Replace the high-pressure cylinders:

- every 3,000 hours
- if the cylinder is chipped or cracked

Install a new plunger bearing when replacing the high-pressure cylinder.

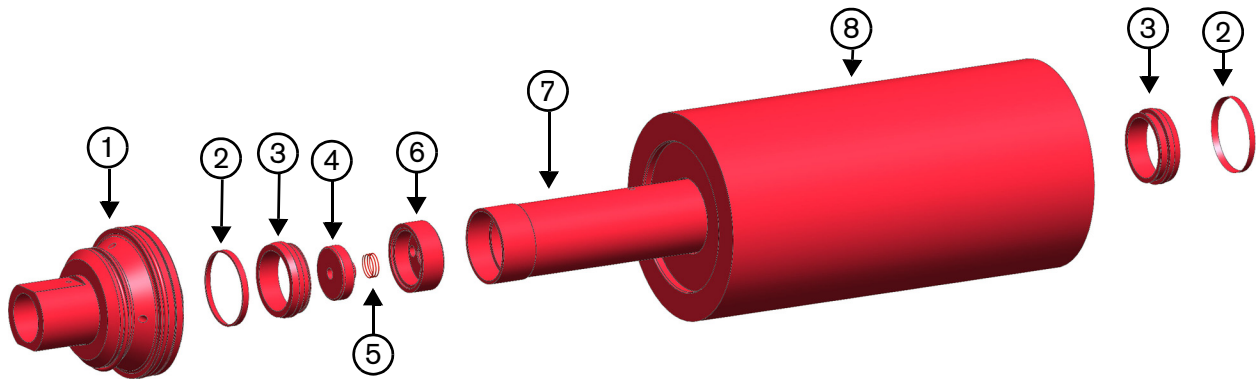

1 1-11523 Check valve assembly

2 1-11018 High-pressure hoop

3 1-11024 High-pressure water seal

4 1-14792 Low-pressure poppet
or
1-11526 Low-pressure poppet

6 1-11520 Low-pressure poppet basket

7 1-11521 Spacer tube

8 1-11522 High-pressure cylinder



Parts, tools, and materials

1-17437 HyPrecision premium high-pressure seal repair kit

1-15565 HyPrecision poppet repair kit
(for HyPrecision P-15/P-30/P-50 pumps)

or

1-15568 HyPrecision poppet repair kit
(for HyPrecision P-50S/P-60S/P-75S pumps)

1-11523 Check valve assembly

1-11520 Low-pressure poppet basket

1-11521 Spacer tube

1-11522 High-pressure cylinder

High-pressure antiseize lubricant such as Blue
Goop or PURE Goop

Seal installation tools (refer to page 72)

Rubber mallet

5 – Preventive maintenance

1. Put the seal installation spacer tool on a clean, dry surface.
2. Put the high-pressure cylinder over the spacer tool so that the tool fits in the cylinder bore.



3. Put the poppet spring on the low-pressure poppet.



Intensifiers for HyPrecision P-50S/P-60S/P-75S pumps do not have a low-pressure poppet spring.

HyPrecision P-50S/P-60S/P-75S pumps do not have a low-pressure poppet spring.

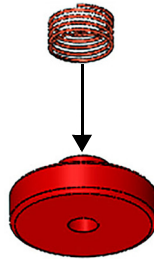

4. Put the low-pressure poppet into the low-pressure poppet basket.



Keep the poppet and the poppet basket clean. Grease can cause the poppet to stick.

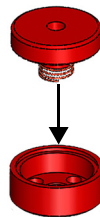

Make sure that the poppet moves easily.

5. Put the low-pressure poppet basket with the low-pressure poppet into the spacer tube.



5 – Preventive maintenance

6. Put the spacer tube into the high-pressure cylinder.

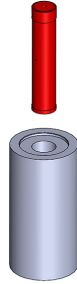

7. Put the seal installation locator tool on top of the cylinder.



8. Put the seal installation sleeve in the locator tool with the flat opening toward the cylinder.
The beveled opening faces up.

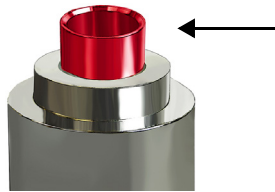

9. Put a small quantity of high-vacuum grease on the red O-ring.
10. Put the red O-ring into the groove on the high-pressure water seal.

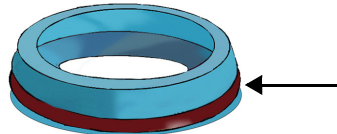

11. Put the high-pressure water seal into the insertion sleeve with the red O-ring toward the cylinder.



5 – Preventive maintenance

- 12.** Put the push tool into the insertion sleeve with the stepped end up. Apply even pressure while holding the sleeve tightly against the cylinder.



- 13.** Remove the push tool from the insertion sleeve.
14. Make sure that the seal is installed in the cylinder correctly.

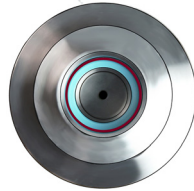

- 15.** Put the hoop into the insertion sleeve with the sharp edge toward the cylinder.

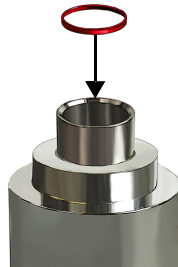

- 16.** Put the push tool into the insertion sleeve with the stepped end up. Tap the push tool sleeve with a rubber mallet until the push tool touches the sleeve.

Hold the sleeve tightly in the cylinder while tapping the push tool.

- 17.** Remove the seal insertion push tool, the sleeve, and the locator.
18. Make sure that the hoop edges are even with the surface of the cylinder. If the edges are not even with the surface of the cylinder, put the nonstepped end of the push tool on the hoop and tap the push tool with a rubber mallet.

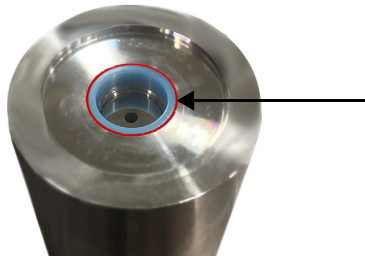

5 – Preventive maintenance

- 19.** Put the end of the check valve into the seal. Tap on the small end of the check valve with a rubber mallet until it is touching the cylinder end.

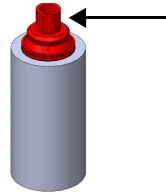

- 20.** Turn the cylinder over so that the check valve is on the bottom. Put 1 hand under the bore at the bottom of the cylinder to catch the spacer tool and to prevent the spacer tube from sliding out.
- 21.** Use the same procedure to install the second seal and the hoop in the high-pressure cylinder.
- 22.** Put the cylinder and the check valve on to the plunger by pushing on the end of the check valve until the cylinder is touching the seal housing.

5 – Preventive maintenance

Install the high-pressure end caps

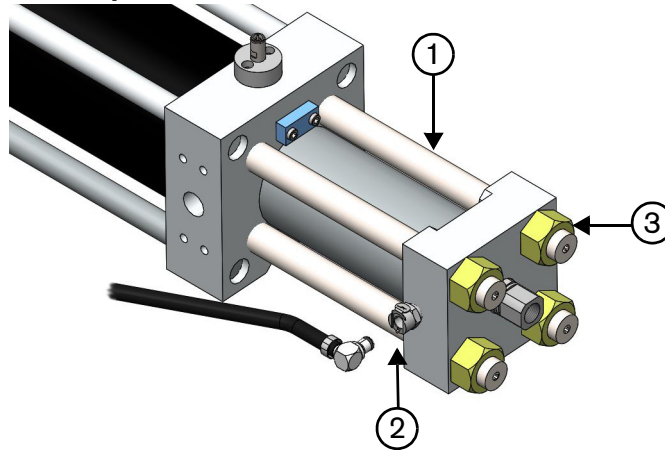

1 Stud

2 Low-pressure water fitting

3 High-pressure end cap nuts



Parts, tools, and materials

1-13186 Antiseize bolt lubricant
(white lithium grease)

High-pressure antiseize lubricant such as Blue
Goop or PURE Goop

Torque wrench, 3/4-inch drive, 60 lbf-ft
to 300 lbf-ft
(included in the 1-12084 HyPrecision standard
tool kit)

Square drive socket, 1-1/2 inch × 3/4 inch
(included in the 1-12084 HyPrecision standard
tool kit)

1-13969 Petroleum-based O-ring lubricant

1. Put O-ring lubricant on the check valve O-rings. Put the O-rings on the check valve.

 The O-rings are installed on the larger outer diameters of the check valve to seal on the inner diameter of the high-pressure end cap.

2. Install the gasket in the groove in the high-pressure end cap. The cutout in the gasket directs fluid down into the drip tray.

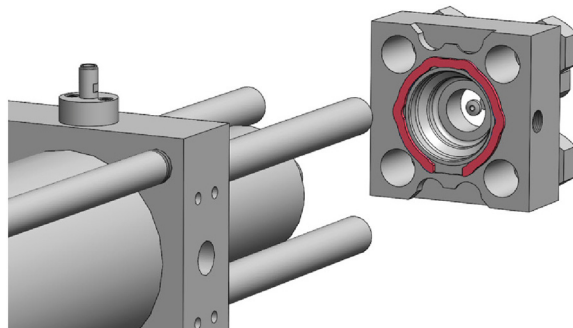

5 – Preventive maintenance

3. Put the high end cap onto the check valve and the studs with the water fitting pointed toward the attenuator.
4. Put antiseize bolt lubricant on the stud threads.
5. Tighten the nuts on the studs by hand.

Put the smooth side of the nut toward the high-pressure end cap.

6. Torque the end cap nuts to 375 N·m (275 lbf·ft).

Tighten each fastener in 68 N·m (50 lbf·ft) increments. Use a repeating cross pattern.

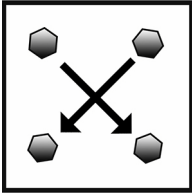

7. Connect the low-pressure water line.
8. Install the drip tray under the high-pressure end.

5 – Preventive maintenance

Install the output adapter and the high-pressure poppet assembly

Repair the high-pressure poppet assemblies every 1,000 hours.

Replace the output adapters every 6,000 hours.

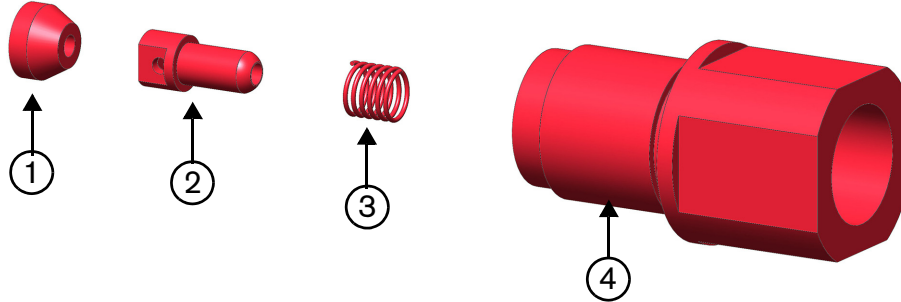

1 1-11010 High-pressure poppet seat

2 1-11014 High-pressure poppet

3 1-11126 High-pressure poppet spring

4 1-11530 Output adapter



Parts, tools, and materials

1-17437 HyPrecision premium high-pressure seal repair kit

1-15565 HyPrecision poppet repair kit (for HyPrecision P-15/P-30/P-50 pumps)

or

1-15568 HyPrecision poppet repair kit (for HyPrecision P-50S/P-60S/P-75S pumps)

1-11530 Output adapter

High-pressure antiseize lubricant such as Blue Goop or PURE Goop

1-inch crowfoot wrench or socket

13/16-inch open-ended wrench

Torque wrench

1. Use a cotton-tipped applicator to put high-pressure antiseize lubricant in the recess in the bottom of the check valve.

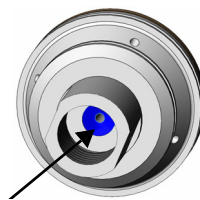

2. Use a cotton-tipped applicator to guide the high-pressure poppet seat into the check valve. The wide end of the poppet seat faces toward the check valve.

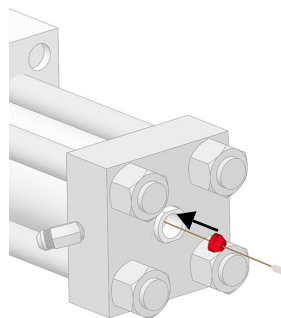

3. Push the poppet seat into the high-pressure antiseize lubricant in the check valve.

5 – Preventive maintenance

- Put high-pressure antiseize lubricant on the threads of the output adapter.

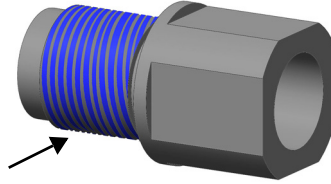

- Put the high-pressure poppet spring and the high-pressure poppet in the output adapter.
- Put the output adapter in the check valve and tighten it by hand.



Tightening the output adapter with the poppet in an incorrect position can cause damage.
When the output adapter is correctly installed, the gap between the wide part of the output adapter and the check valve is 10 mm (3/8 inch) and no threads are visible. If the gap is too large or if threads are visible, make sure that the poppet parts have not moved.

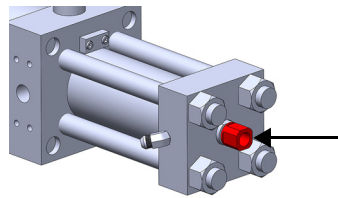





- Torque the output adapter to 115 N·m (85 lbf·ft).
- Put high-pressure antiseize lubricant on the high-pressure connector threads.
- Connect the high-pressure tubing.



Make sure that some of the threads on the high-pressure tubing are visible at the fitting. Refer to **Special fasteners on page 187.**

- Torque the high-pressure water fitting to 68 N·m (50 lbf·ft).

High-pressure water system: Bleed-down valve

 WARNING	Do not tighten a fitting too much. The fitting can fail.
	Identify the source of a leak and correct the problem. Refer to Leaks on page 163. A leak can cause damage to the water fittings.
	Put the parts on a clean, dry surface.
	Examine parts that are being replaced to identify wear patterns or damage that can show other problems.
	Clean each part with a towel and isopropyl alcohol. Examine all parts for deterioration, corrosion, or damage. Do not use soap, detergent, or solvents.

Repair the bleed-down valve:

- Every 1,000 hours
- If water leaks from the WASTE WATER OUT connection or from the weep holes while the pump is operating

Replace the bleed-down valve every 3,000 hours.

Refer to the **Parts lists** section, which starts on page 137.

Remove the bleed-down valve from the pump



Parts, tools, and materials

- 5/8-inch open-ended wrench
- 3/4-inch open-ended wrench
- 13/16-inch open-ended wrench
- 1-inch open-ended wrench
- Phillips screwdriver

Do this task when the pump is not operating.

1. Disconnect the compressed air supply hose from the fitting on top of the actuator.
2. Disconnect the water drain tube from the bleed-down valve.
3. Remove the gland nut on the high-pressure collar at the high-pressure fitting of the valve.
4. Remove the bleed-down valve assembly from the pump.

Disassemble the bleed-down valve

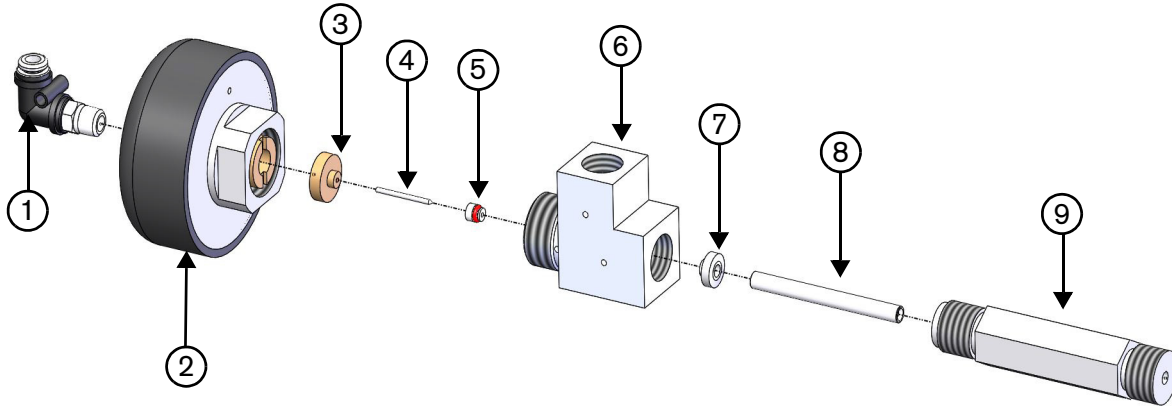

- | | |
|---|---|
| 1 Air fitting | 6 1-14141 Bleed-down valve body |
| 2 Actuator | 7 1-11010 High-pressure poppet seat |
| 3 Needle bushing | 8 1-17336 Air-actuated bleed-down valve flow reducer |
| 4 1-11562 Needle | 9 Outlet adapter |
| 5 1-11043 High-pressure valve seal | |



Parts, tools, and materials

Clean towels

Isopropyl alcohol

3/4-inch open-ended wrench

1-1/8-inch open-ended wrench
(to hold the valve body)

Wooden dowel

1. Remove the outlet adapter from the valve body.
2. Remove the seat and the flow reducer from the outlet adapter.
3. Remove the actuator from the valve body.
4. Push a dowel through the bottom of the valve body to remove the seal, the needle guide, and the needle.
5. Clean each part with a towel and isopropyl alcohol. Examine all parts for deterioration, corrosion, or damage

Assemble the bleed-down valve

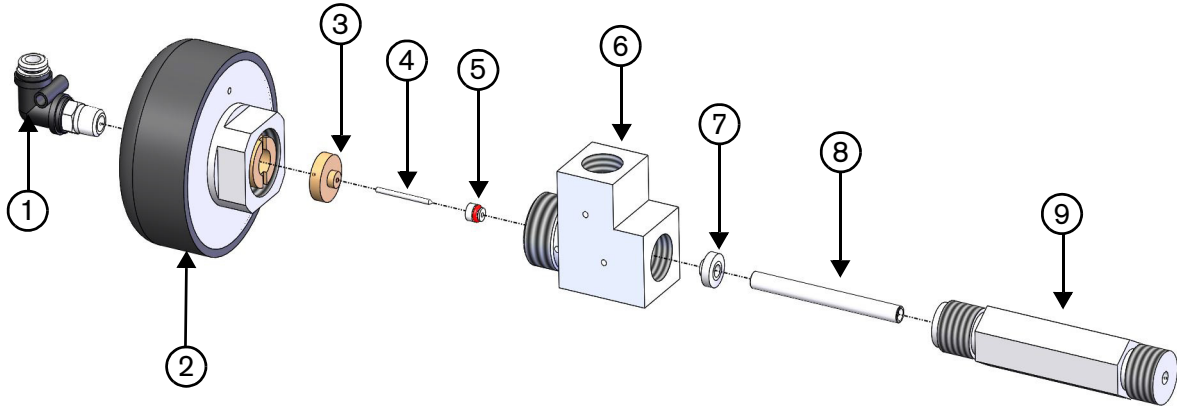

- | | |
|---|---|
| 1 Air fitting | 6 1-14141 Bleed-down valve body |
| 2 Actuator | 7 1-11010 High-pressure poppet seat |
| 3 Needle bushing | 8 1-17336 Air-actuated bleed-down valve flow reducer |
| 4 1-11562 Needle | 9 Outlet adapter |
| 5 1-11043 High-pressure valve seal | |



Parts, tools, and materials

- 1-17434 Bleed-down valve repair kit
- High-pressure antiseize lubricant such as Blue Goop or PURE Goop
- 1-inch open-ended wrench
- 3/4-inch open-ended crowfoot wrench or socket
- Torque wrench

Recommended materials

- Vise

1. Put high-pressure antiseize lubricant on the seat.
2. Put the flow reducer into the outlet adapter.
3. Put the seat into the outlet adapter.
4. Install the outlet adapter in the bleed-down valve body. Torque the adapter to 95 N·m (70 lbf·ft).

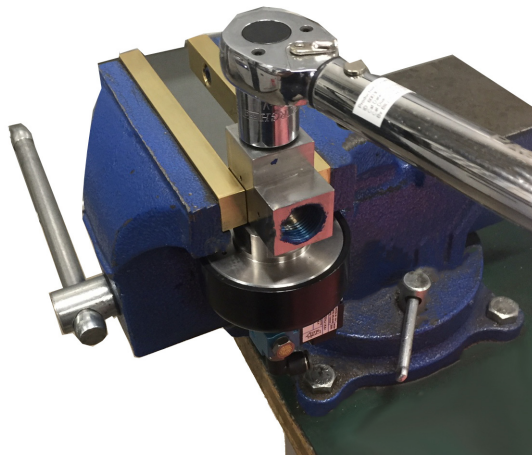

5 – Preventive maintenance

5. Put the needle through the needle guide and the valve seal. Make sure that the point of the needle faces the seal.
6. Put high-vacuum grease on the red O-ring on the valve seal. Make sure that the red O-ring on the valve seal faces away from the needle.
7. Put the needle-and-seal assembly into the valve body until the needle guide is even with the top of the bore.
8. Install the actuator on the valve body. Tighten the actuator by hand.

Install the bleed-down valve









Parts, tools, and materials

5/8-inch open-ended wrench
3/4-inch open-ended wrench
13/16-inch open-ended wrench
1-inch open-ended wrench
Torque wrench

1. Tighten the gland nut on the high-pressure collar at the high-pressure fitting of the valve.
Refer to **Special fittings** on page 189 for torque values.
2. Connect the water drain tube to the bleed-down valve.
3. Connect the compressed air hose to the fitting on top of the actuator.
4. Turn on the water to the pump.
5. Monitor for leaks.

Start the pump after maintenance

 DANGER	<p>Before removing a lock-out device:</p> <ul style="list-style-type: none"> ▪ Obey the employer’s energy-control procedure. ▪ Examine machines and parts to make sure that they are operational. ▪ Make sure that all personnel are safely away from machines. <p>After removing energy-isolation devices, make sure that all personnel in the area of the equipment know that the devices are removed and that the machine is being energized.</p>
 WARNING	<p>A turning motor shaft can be dangerous. Close all doors and replace all covers, including access covers.</p>
 WARNING	<p>Do not try to repair a leak with pressure in the system.</p>
 WARNING	<p>Remove all tools, towels, and rags from the work area before starting the equipment.</p>
 CAUTION	<p>Make sure that all fittings are tight after doing maintenance on or repairs to this equipment.</p>
 	<p>Identify the source of a leak and correct the problem. Refer to Leaks on page 163. A leak can cause damage to the water fittings.</p>

1. Turn ON the electrical breaker.
2. Turn ON the water to the pump.
3. Monitor for leaks.
4. Turn ON the compressed air supply.
5. Turn ON the electrical main.
6. Turn the primary breaker disconnect lever on the electrical enclosure door to ON.

The operator interface screen is on when the pump is energized.

7. Make sure that the LOCAL/REMOTE key switch on the operation panel is set to LOCAL. Refer to **Operator interface: Operation screens** on page 58 for information.

When the key switch is set to LOCAL:

- The operator interface is used to operate the pump.
 - The REMOTE ON indicator light is off.
 - The operator interface is the primary point of control.
8. Push the CONTROLS ON button to turn ON the control circuit in the pump.



The pump can not be turned on until the control circuit is on.

9. Turn ON the pump in cooling mode.
10. The post-maintenance start program operates. Refer to **Postmaintenance start procedure** on page 132.
11. Monitor for leaks.

Operator interface: Maintenance screens

The maintenance screens on the operator interface let the user log and track all maintenance performed on the pump and the intensifier.

i	Not all screens are used when doing maintenance on the pump.
i	Touch the current screen symbol to go back 1 screen.

To use the maintenance screens, touch a symbol with a border around it. This usually opens another screen.

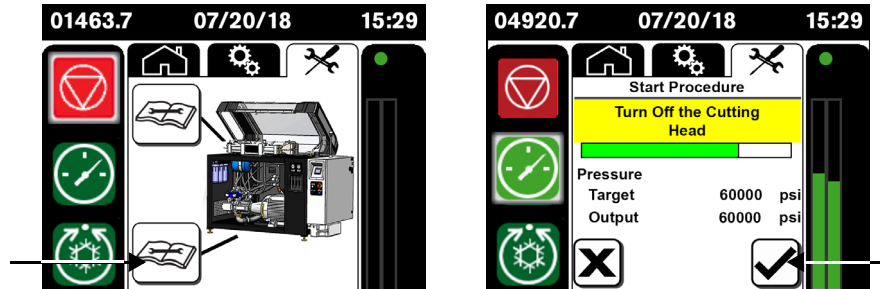

A field with no border shows that the item is informational.

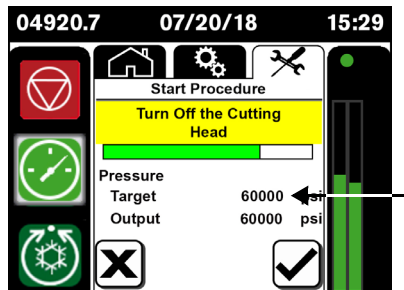

5 – Preventive maintenance

Primary maintenance screen

On the operator interface, touch the maintenance symbol to open the primary maintenance screen.

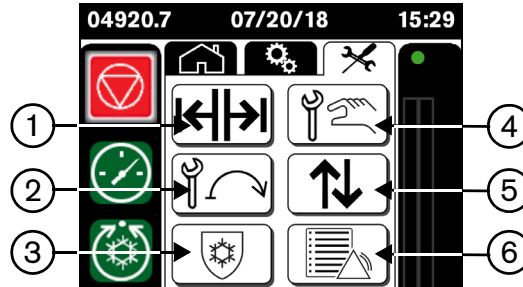

- | | | | |
|---|----------------------------------|---|--------------------|
| 1 | Move the plunger | 4 | Record maintenance |
| 2 | Start the pump after maintenance | 5 | Inputs and outputs |
| 3 | Prepare for storage | 6 | Alarm log |



Move the plunger

Touch this symbol to open the *Move the Plunger* screen.

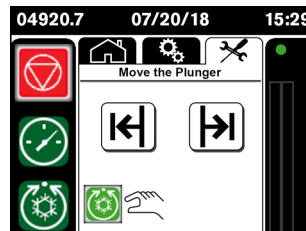

Touch a symbol to manually shift the intensifier plunger to the left or to the right.



The unit must be in cooling mode. The cooling symbol with a hand flashes as a reminder.



Start the pump after maintenance

Touch this symbol to open the *Start Procedure* screen. Refer to **Postmaintenance start procedure** on page 132 for instructions.

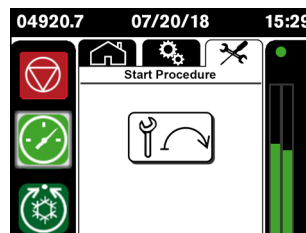

5 – Preventive maintenance



Prepare for storage

Touch this symbol to open the *Prepare for Storage* screen. Refer to **Prepare for storage** on page 135 for instructions.

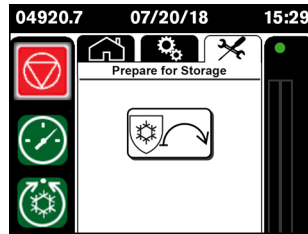

Record maintenance

1. Touch this symbol to open the Maintenance Selection screen.

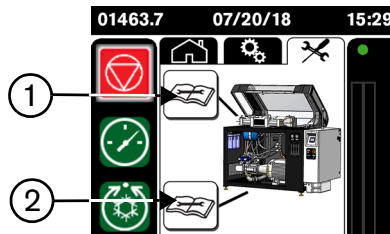

- 1 Intensifier
- 2 Pump components

2. To open the Intensifier Maintenance screen, touch the repair symbol on the top.

To open the Pump Components screen, touch the repair symbol on the bottom. Go to *step 7* on page 131.

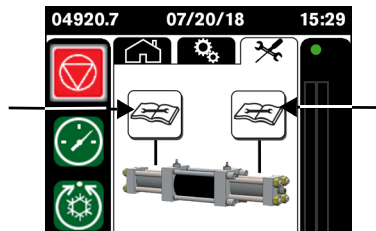

3. Touch the repair symbol for the right or left end of the intensifier.

There are 3 Intensifier Components screens. Touch an arrow symbol at the bottom of a screen to move between the screens.

4. Touch the symbol on the screen for each component that was replaced.

5 – Preventive maintenance

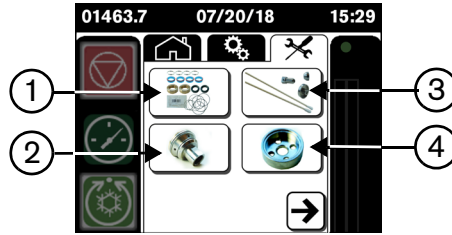

- | | |
|--|--|
| <p>1 HyPrecision premium high-pressure seal repair kit
1-17437
500 hours</p> <p>2 Check valve assembly
1-11523
1,500 hours</p> | <p>3 HyPrecision poppet repair kit
1-15565 (for HyPrecision P-15/P-30/P-50 pumps)
or
1-15568 (for HyPrecision P-50S/P-60S/P-75S pumps)
1,000 hours</p> <p>4 Low-pressure poppet basket
1-11520
1,500 hours</p> |
|--|--|

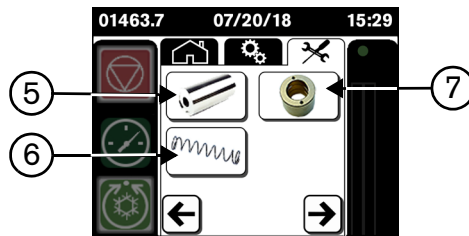

- | | |
|---|---|
| <p>5 High-pressure cylinder
1-11522
3,000 hours</p> <p>6 Indicator pin spring
1-11669
3,000 hours</p> | <p>7 Plunger bearing
1-11608
3,000 hours</p> |
|---|---|

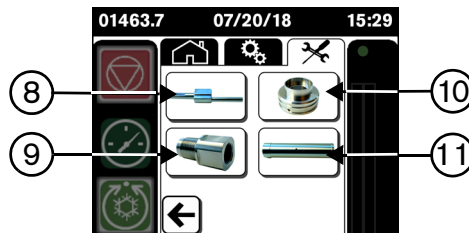

- | | |
|--|---|
| <p>8 Indicator pin
1-11518
6,000 hours</p> <p>9 Output adapter
1-11530
6,000 hours</p> | <p>10 Seal housing
1-11609
6,000 hours</p> <p>11 Spacer tube
1-11521
12,000 hours</p> |
|--|---|

After a symbol is selected, the Maintenance Reason screen opens.

5 – Preventive maintenance

- Touch the applicable symbol on the screen to record the reason that the part was replaced. This information is saved as a .CSV file on the SD card.

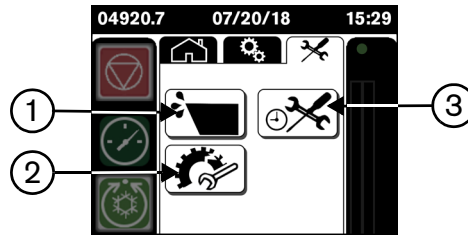

- | | |
|------------------------------|---|
| 1 Leak | 3 Scheduled preventive maintenance |
| 2 Worn or broken part | |

- If maintenance is done on both ends of the intensifier, do these steps again for the other high-pressure end.
- Touch the bottom repair symbol on the Record Maintenance screen to open the Pump Components screen.

There is 1 Pump Components screen.

- Touch the symbol on the screen for the part that was replaced.

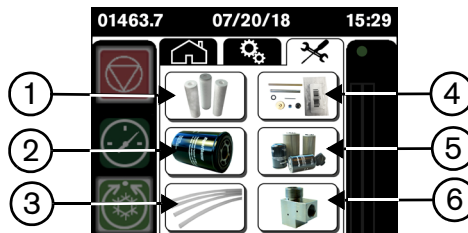

- | | |
|---|--|
| 1 Water filter cartridges
1-15470 (0.22 micron)
1-11106 (1.0 micron)
1-11107 (10 micron)
1,000 hours | 4 Bleed-down valve repair kit
1-17434
1,000 hours |
| 2 Hydraulic filter
1-16025
1,500 hours | 5 Hydraulic fluid service kit
1-17473
3,000 hours |
| 3 Seal Maintenance Indicator tubes
replacement kit
1-17483
2,000 hours | 6 Bleed-down valve body
1-14141
3,000 hour |

After a symbol is selected, the Maintenance Reason screen opens.

5 – Preventive maintenance

9. Touch the applicable symbol on the screen to record the reason that the part was replaced. This information is saved as a .CSV file on the SD card.

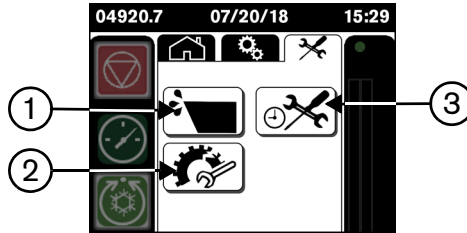

- 1 Leak
2 Worn or broken part
3 Scheduled preventive maintenance



Inputs and outputs

Touch this symbol to open the screen that shows inputs and outputs for the controller.

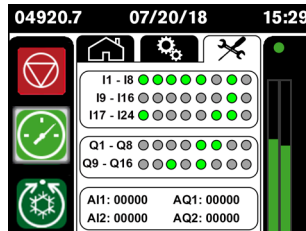

Refer to **Controller problems** on page 175 for detailed description.



Alarm log

Touch this symbol to open the **Alarm Log** screen.

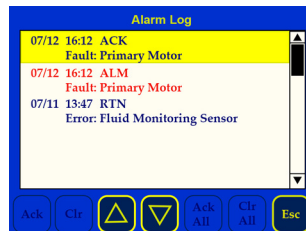

Postmaintenance start procedure

Touch the X symbol to stop the sequence and turn off the pump.

The automatic start procedure is designed to break in the pump after maintenance. A consistent, smooth start procedure after maintenance can improve high-pressure seal life.

5 – Preventive maintenance

This operator interface shows the start procedure stage that the pump is in, a progress, bar, and the target and output pressures.

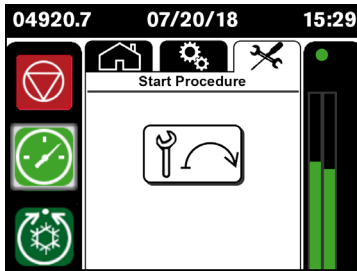

Stage 1: Supply water pressure

Touch the symbol on the **Start Procedure** screen.

- The beacon light flashes green at 1-second intervals during the start procedure.
- The primary motor starts.
- If the system has a boost pump, it turns on.
- The hydraulic pump operates at minimum pressure.
- The controller monitors the supply water pressure until the pressure gets to the water manifold pressure setpoint.

The setpoint is based on the pump model.

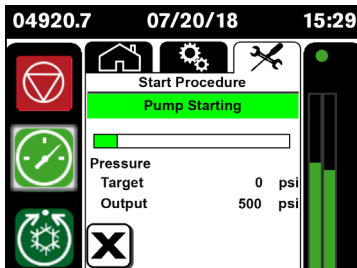

Stage 2: Remove air from the system

- The intensifier starts stroking.
- **Pump Starting** flashes on the screen at 1-second intervals.
- The intensifier pushes water through the system and pushes air out through the bleed-down valve.
- Supply water causes the water pressure in the system to increase.
- The Supply Water Start Procedure timer expires.
- The bleed-down valve is open.

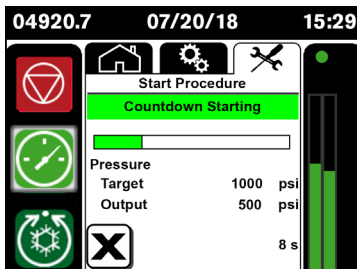

Stage 3: Charge the system

- The bleed-down valve closes.
- **Countdown Starting** flashes on the screen at 1-second intervals.
- The intensifier strokes to increase the water pressure in the system.

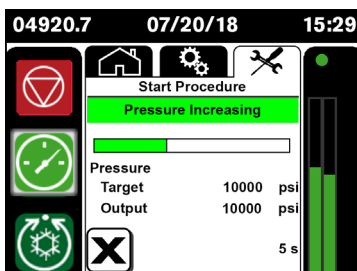

Stage 4: Pressure Increasing

- The target pressure increases to 690 bar (10,000 psi).
- **Pressure Increasing** flashes on the screen at 1-second intervals.
- The intensifier strokes to increase the water pressure in the system.

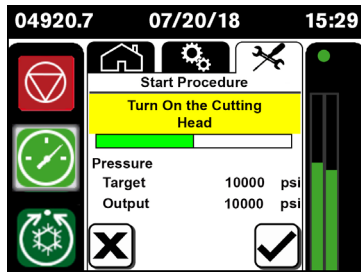

Stage 5: Turn On the Cutting Head

Turn On the Cutting Head flashes on the screen at 1-second intervals.

1. Move the cutting head to a safe location on the table.
2. Turn ON the cutting head.
3. Touch the ✓ symbol.

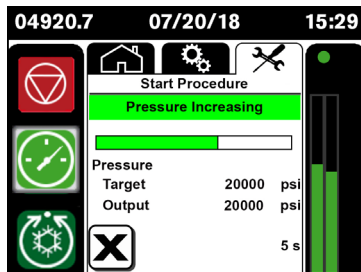

Stage 6: Pressure Increasing

Pressure Increasing flashes on the screen at 1-second intervals.

- The intensifier strokes to increase the water pressure in the system.
- The target pressure increases to 1,380 bar (20,000 psi).
- The target pressure increases to 2,070 bar (30,000 psi).
- The target pressure increases to 2,760 bar (40,000 psi).
- The target pressure increases to 3,450 bar (50,000 psi).
- The target pressure increases to 4,140 bar (60,000 psi).

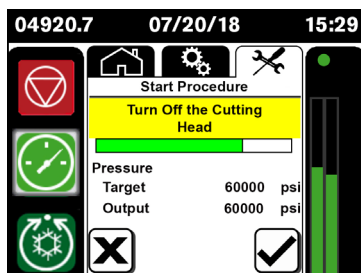

Stage 7: Close the Cutting Head

Turn Off the Cutting Head flashes on the PLC screen at 1-second intervals.

1. Turn OFF the cutting head.
2. Touch the ✓ symbol.

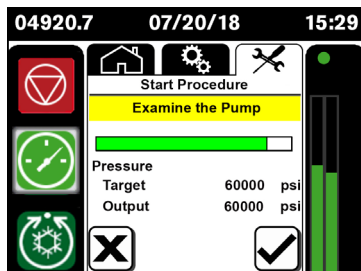



Stage 8: Examine the Pump

Examine the Pump flashes on the screen at 1-second intervals.

1. Examine the pump for loose fittings or leaks.
2. Touch the ✓ symbol.
 - The main motor turns off.
 - The primary operation screen opens.

The pump is ready for operation.

Prepare for storage

	Do not dry the cooling circuit of an air-cooled system.
	High-pressure water can cause eye injuries. Wear approved eye protection when operating or doing work near this equipment. Do not stand over components such as tubes or valves while drying the system.

1. Remove the water filters from the filter canisters. Refer to **Replace the water filters** on page 93.
2. Make sure that the filter canisters are empty.
3. Install the water filter canisters without the filters.
4. Disconnect the compressed air supply hose from the utility panel and connect it to the CUTTING WATER IN connection.
The CUTTING WATER IN connection is 1/2-inch female. An adapter (not included) is necessary.
5. Disconnect the WASTE WATER OUT hose from the utility panel.
6. On the operator interface, touch the symbol on the **Prepare for Storage** screen.
Refer to **Prepare for storage** on page 129.
The cutting water and the cooling water supply valves open.
7. Turn ON the compressed air supply for a minimum of 5 minutes to dry the system.
8. Turn OFF the compressed air supply.
9. Disconnect the compressed air supply hose from the CUTTING WATER IN connection.
10. Water can collect in the filter canisters when the system is cleared. Make sure that the filter canisters are empty.
11. Install the water filter canisters with the filters.
12. Drain hydraulic fluid from the hoses and the heat exchanger.
13. Do this procedure for a water-cooled system.
 - a. Connect the compressed air supply hose to the COOLING IN connection.
The COOLING IN connection is 1-inch NPT female. An adapter (not included) is necessary.
 - b. Disconnect the COOLING OUT hose from the utility panel.
 - c. On the operator interface, touch the symbol on the **Prepare for Storage** screen.
The cutting water and the cooling water supply valves open.
 - d. Turn ON the compressed air supply for at least 2 minutes to dry the system.
 - e. Disconnect the compressed air supply hose from the utility panel.
 - f. On the operator interface, touch the X symbol on the screen to close the water valves.
14. Install the fitting caps and the plugs on the utility panel.

Recycling and end of product life

At the end of the life of the product or its parts, recycle or discard materials and parts. Use an environmentally satisfactory method and in accordance with local regulations. If the product contains substances that could cause damage to the environment, remove and dispose of them in accordance with current local regulations. This includes liquids such as hydraulic fluid.

Make sure that dangerous substances are disposed of safely and that the correct personal protective equipment is used. The safety specifications must be in accordance with the current local regulations at all times.

Section 6

Parts lists

Genuine Hypertherm parts are the factory-recommended replacement parts for this pump. It is possible that the Hypertherm warranty will not cover damage caused by nongenuine Hypertherm parts.

To order parts, contact the original equipment manufacturer (OEM) or Hypertherm, Inc. with the part numbers and quantities.

Hypertherm Waterjet
305 2nd Ave NW, Suite 115
New Brighton, MN 55112 USA
+1 866-566-7099
+1 651-294-8620 fax

Tools

1-12084 HyPrecision standard tool kit

Part number	Description	Quantity
1-11111	Blue Goop® oil-based antiseize lubricant, 57 g (2 oz.)	1
1-13537	PURE Goop® halocarbon-based antiseize lubricant, 28 g (1 oz.)	1
1-13969	Petroleum-based O-ring lubricant, 56 g (2 oz.)	1
1-18038	Antiseize bolt lubricant (white lithium grease)	1
1-11558	Seal installation locator tool	1
1-11811	Seal installation sleeve	1
1-11812	Seal installation push tool	1
1-12932	Seal installation spacer tool	1
1-11985	Seal housing removal tool	1
1-17522	10-32 stainless steel screw (to remove the plunger bearing)	2
1-12019	Hex driver, 3/4 inch × 13-1/2 inch	1
1-12020	Deep square-drive socket, 3/4 inch × 3/4 inch	1
1-12021	Square-drive socket, 1-1/2 inch × 3/4 inch	1
1-12091	Torque wrench, 3/4-inch drive, 60 lbf-ft to 300 lbf-ft	1
1-17490	Breaker bar, 40 inch	1
1-13972	Water filter wrench	1
1-13281	Granite lapping block	1
1-11210-12	Lapping paper, 12 micron	10
1-17520	SMI tube cleaning brush	3

The plastic tool case contains all of these items except:

- The torque wrench has a separate case.
- The granite lapping block is shipped in a wooden box.
- The breaker bar is shipped in a bag.

Maintenance kits

Quantity refers to the number of units included with each part number.

1-17523 HyPrecision basic standard spares kit

for HyPrecision P-15/P-30/P-50 pumps

Part number	Description	Quantity
1-17437	HyPrecision premium high-pressure seal repair kit	2
1-15565	HyPrecision basic poppet repair kit	1
1-17434	Bleed-down valve repair kit	1
1-11669	Indicator pin spring	2
1-11679-013	Indicator pin O-ring, -013	2
1-11680-013	O-ring backup, -013	2
1-15564	Cotton-tipped applicator	2
1-15470	Water filter cartridge, 0.22 micron, 10 inch	1
1-11106	Water filter cartridge, 1.0 micron, 10 inch	1
1-16025	Hydraulic filter	1

1-17482 HyPrecision S-series standard spares kit

for HyPrecision P-50S/P-60S/P-75S pumps

Part number	Description	Quantity
1-17437	HyPrecision premium high-pressure seal repair kit	2
1-15568	HyPrecision S- and D-series poppet repair kit	2
1-17434	Bleed-down valve repair kit	1
1-11669	Indicator pin spring	2
1-11679-013	Indicator pin O-ring, -013	2
1-11680-013	O-ring backup, -013	2
1-15564	Cotton-tipped applicator	2
1-15470	Water filter cartridge, 0.22 micron, 10 inch	1
1-11106	Water filter cartridge, 1.0 micron, 10 inch	1
1-11107	Water filter cartridge, 10 micron, 10 inch	1
1-16025	Hydraulic filter	1

1-15565 HyPrecision basic poppet repair kit

for HyPrecision P-15/P-30/P-50 pumps

Part number	Description	Quantity
1-11014	High-pressure poppet	2
1-11126	High-pressure poppet spring	2
1-11015	High-pressure poppet seat	2
1-14792	Low-pressure poppet	2
1-13907	Low-pressure poppet spring	2
1-15564	Cotton-tipped applicator	2

1-15568 HyPrecision S- and D-series poppet repair kit

for HyPrecision P-50S/P-60S/P-75S pumps

Part number	Description	Quantity
1-11014	High-pressure poppet	2
1-11126	High-pressure poppet spring	2
1-11015	High-pressure poppet seat	2
1-11526	Low-pressure poppet	2
1-15564	Cotton-tipped applicator	2

1-17437 HyPrecision premium high-pressure seal repair kit

for all HyPrecision pump models

Part number	Description	Quantity
1-11018	High-pressure hoop, 1 inch	4
1-11024	High-pressure water seal, 1 inch	4
1-11447	High-vacuum grease, 5 g (.2 oz.)	1
1-11610	High-pressure seal backup (bronze)	2
1-11090	Hydraulic rod seal, 1 inch	2
1-11679-035	Check valve and seal housing O-ring, -035	4
1-11679-031	Check valve O-ring, -031	2
1-11680-035	O-ring backup, -035	2
1-11679-011	Seal housing O-ring, -011	2
1-17410	High-pressure end cap gasket	2

1-17434 Bleed-down valve repair kit

for all HyPrecision pump models

Part number	Description	Quantity
1-11010	High-pressure poppet seat	1
1-11562	Needle	1
1-12178	Needle guide	1
1-11043	High-pressure valve seal	1
1-11679-011	O-ring, -011	1
1-17336	Air-actuated bleed-down valve flow reducer	1
1-16577	Wooden dowel	1
1-11447	High-vacuum grease, 5 g (.2 oz.)	1

1-17473 Hydraulic fluid service kit

for all HyPrecision pump models

Part number	Description	Quantity
1-11960	Suction strainer, 2-1/2 inch	1
1-12438	Suction strainer, 1-1/2 inch	1
1-14629	Filler-breather cap	1
1-15888	Flat washer, 5/8-inch (crush washer for hydraulic tank access cover)	1
1-16092	Access cover gasket	1
1-16025	Hydraulic filter	2

Replacement parts

Electrical system

Part number	Description
1-11670	Proximity switch
1-17407	Interlock override key
1-17309	Electrical interlock kit, HyPrecision P-15/P-30/P-50
1-17310	Electrical interlock kit, HyPrecision P-50S/P-60/P-75
1-17293	Electrical interlock bracket, HyPrecision P-50S/P-60S/P-75S

Hydraulic system

Part number	Description
1-11733	Shift valve and pilot assembly, 24 VDC
1-16435	Shift valve O-ring kit
1-12617	Switch, temperature and fluid level
1-11964	Return diffuser, 2 inch
1-17348	Hydraulic transducer
1-17349	Hydraulic high-pressure relief valve, preset
1-17347	Proportional cartridge valve and coil
1-18053	Service kit, gear pump, HyPrecision P-15/P-30
1-18054	Service kit, gear pump, HyPrecision P-50/P-50S/P-60S/P-75S
1-18040	Service kit, hydraulic pump, HyPrecision P-15
1-18041	Service kit, hydraulic pump, HyPrecision P-30
1-18042	Service kit, hydraulic pump, HyPrecision P-50/P-50S
1-18043	Service kit, hydraulic pump, HyPrecision P-60S/P-75S
1-18044	Service kit, hydraulic shaft seal, HyPrecision P-15
1-18045	Service kit, hydraulic shaft seal, HyPrecision P-30
1-18046	Service kit, hydraulic shaft seal, HyPrecision P-50/P-50S
1-18047	Service kit, hydraulic shaft seal, HyPrecision P-60S/P-75S
1-18048	Service kit, hydraulic O-rings, HyPrecision P-15
1-18049	Service kit, hydraulic O-rings, HyPrecision P-30
1-18050	Service kit, hydraulic O-rings, HyPrecision P-50/P-50S
1-18051	Service kit, hydraulic O-rings, HyPrecision P-60S/P-75S
1-18052	Service kit, compensator

Low-pressure water system

Part number	Description
1-13897	TDS meter
1-11829	Water filter canister
1-11679-237	O-ring, low-pressure filter canister
1-11835	Water accumulator tank
1-12614	Cooling solenoid valve, brass, 1/2-inch NPT, 24 VDC
1-17337	Water manifold assembly
1-17361	Water manifold solenoid valve, low-pressure water drain
1-17362	Water manifold solenoid valve, supply cutting water
1-17359	Water manifold relief valve
1-17360	Water manifold transducer
1-12056	Boost pump motor, 1/2 hp
1-12057	Boost pump, 100 gallons per hour, HyPrecision P-50S/P-60S/P-75S

Tube replacement kits

Part number	Description
1-17487	Push-to-connect fittings kit
1-17435	Intensifier inlet water tubes kit

External plumbing kit

Part number	Description
1-15578	Pump-mounted plumbing kit

For HyPrecision P-15/P-30/P-50 pumps

Part number	Description
1-17495	Complete low-pressure tubes and fittings kit
1-17499	Water manifold tubes replacement kit
1-17500	Cooling tubes replacement kit
1-17497	Bleed-down valve replacement tube

For HyPrecision P-50S/P-60S/P-75S pumps

Part number	Description
1-17496	Complete low-pressure tubes and fittings kit
1-17493	Water manifold tubes replacement kit
1-17488	Cooling tubes replacement kit
1-17498	Bleed-down valve replacement tube

Seal Maintenance Technology™

Part number	Description
1-17076	Seal Maintenance Indicator™ (SMI) assembly
1-16329	Drip tray
1-17501	Seal Maintenance Indicator tubes replacement kit, HyPrecision P-15/P-30/P-50
1-17502	Seal Maintenance Indicator transport tubes replacement kit, HyPrecision P-15/P-30/P-50
1-17483	Seal Maintenance Indicator tubes replacement kit, HyPrecision P-50S/P-60S/P-75S
1-17489	Seal Maintenance Indicator transport tubes replacement kit, HyPrecision P-50S/P-60S/P-75S
1-17385	Dirty water container

High-pressure water system

Part number	Description
1-12280	Attenuator assembly, 1 liter
1-11595	Attenuator assembly, 2 liter
1-14141	Bleed-down valve body
1-12579	Protective sheathing, 1/4 inch
1-12580	Protective sheathing, 3/8 inch
1-14688	Sheathing end cover, 1/4-inch high-pressure tubing
1-14687	Sheathing end cover, 3/8-inch high-pressure tubing
1-17340	Air-actuated bleed-down valve assembly
1-11518	Indicator pin
1-11519	Indicator pin cap
1-11798	Split support ring

Intensifier high-pressure ends

Part number	Description
1-11523	Check valve assembly
1-11520	Low-pressure poppet basket
1-11530	Output adapter
1-11522	High-pressure cylinder
1-11609	Seal housing
1-11521	Spacer tube
1-11608	Plunger bearing
1-17437	HyPrecision premium high-pressure seal repair kit (for all HyPrecision pump models)
1-15565	HyPrecision basic poppet repair kit (for HyPrecision P-15/P-30/P-50 pumps)
1-15568	HyPrecision S- and D-series poppet repair kit (for HyPrecision P-50S/P-60S/P-75S pumps)

Other parts

Lubricants

Part number	Description
1-11111	Blue Goop® oil-based antiseize lubricant, 57 g (2 oz.)
1-13537	PURE Goop® halocarbon-based antiseize lubricant, 28 g (1 oz.)
1-11448	AccuGoop™ food-grade antiseize lubricant, 113 g (4 oz.)
1-11447	High-vacuum grease, 5 g (.2 oz.)
1-13969	Petroleum-based O-ring lubricant, 56 g (2 oz.)
1-13186	Antiseize bolt lubricant (white lithium grease), 411 g (14.5 oz.)

Fittings

Part number	Description
1-13157-60-4	High-pressure collar, 1/4 inch
1-13157-60-6	High-pressure collar, 3/8 inch
1-13158-60-4	High-pressure gland nut, 1/4 inch
1-13158-60-6	High-pressure gland nut, 3/8 inch
1-13495	High-pressure antivibration fitting assembly, 1/4 inch
1-14266	High-pressure antivibration fitting assembly, 3/8 inch

Top covers

Part number	Description
1-16834	Top cover, HyPrecision P-15/P-30/P-50
1-17304	Top cover, HyPrecision P-50S/P-60S/P-75S

Memory card

Part number	Description
1-17355	SDHC MicroSD memory card, 32GB

Section 7

Troubleshooting













The HyPrecision Predictive pump features technology that helps a user anticipate a high-pressure seal failure. This adds flexibility to the cutting schedule and prevents unscheduled downtime.

In this section



- Safety
- Normal status
- Alarms
 - Warnings
 - Faults
- Intensifier problems
- Hydraulic fluid
- Water
- Seal Maintenance Indicator (SMI)
- A warning or a fault occurs during the start sequence
- The pump makes noise during operation
- Controller problems

i	This section assumes that the user is familiar with the Safety, Operation, and Pump specifications sections of this manual.
	Keep accurate maintenance records. Records can help with predicting and preventing maintenance problems.
	Use the maintenance log feature to record maintenance performed on the pump and the intensifier. Refer to Record maintenance on page 129 for instructions.
	It is possible that not all of the information in this section applies to all pump models.

Safety

	<p>Refer to the instruction manual. Read and understand all of the safety guidelines in this manual.</p>
 DANGER	<p>A waterjet is a cutting tool. Keep away from high-pressure streams and leaks. Pressurized fluid can cause injuries.</p> <p>A high-pressure injection injury is a surgical emergency. Get medical treatment immediately for all high-pressure waterjet injuries.</p> <p>Delayed treatment can cause injuries or death. Abrasive waterjets eject a mixture of water and abrasive materials that can be injected into body tissues, leading to a dangerous infection.</p>
 DANGER	<p>DANGEROUS VOLTAGE/RISK OF SHOCK</p> <p>To reduce the risk of injuries or death, wear approved protection and obey safety recommendations when doing work with electricity.</p>
 DANGER	<p>Doing work on this equipment while it is energized is dangerous.</p> <p>Personnel who maintain and repair this equipment can be injured or killed if dangerous energy is not controlled. Injuries can include burns, cuts, fractures, or electrocution.</p> <p>Before opening the electrical enclosure or doing maintenance or repairs on this equipment, turn off the electrical power and release water pressure and hydraulic pressure from the system.</p> <p>Use standard lock out–tag out procedures. Isolate all sources of electrical, mechanical, hydraulic, pneumatic, chemical, thermal, or other energy with a lockable energy-isolating device that satisfies national and local requirements.</p> <p>All work that requires opening the electrical enclosure or removing covers or panels from this equipment must be done only by an approved technician.</p>
 DANGER	<p>A person who works on deenergized machinery can be injured or killed if the machinery is energized without permission.</p> <p>All personnel in an area where energy-control procedures are used must receive training for energy-control procedures.</p>
 DANGER	<p>Do not stand in line with high-pressure fittings when operating this equipment. If a high-pressure fitting fails, it can cause a stream of water or hydraulic fluid to eject from the system with force.</p>
 WARNING	<p>Personal protective equipment is recommended. If you do not use personal protective equipment, there is a risk of injury or death.</p>
 WARNING	<p>Permit only approved personnel to operate, maintain, and repair this machinery.</p>
 WARNING	<p>Release all high-pressure water before doing work on this equipment.</p>
 WARNING	<p>When work must be done in a small space or an area with limited access, the access must not be blocked by ventilation ducts, hoses, pipes, or other equipment.</p>
 WARNING	<p>Do not operate the pump without the shaft access cover and all other safety devices correctly installed.</p>
 WARNING	<p>Make sure that all connections, fasteners, locking devices, hoses, and fittings are tight before operation.</p>

7 – Troubleshooting

 CAUTION	<p>Do not touch a hot surface. Water leaking from a high-pressure fitting or the bleed-down valve can be hot.</p>
	<p>Obey all safety requirements and applicable safety laws and regulations.</p>
i	<p>Use SAE tools for most procedures.</p>
	<p>Coordinate maintenance and repairs with facility and safety staff.</p>
	<p>Keep the work area clean and dry. Clean fluid spills immediately. Use catch basins under areas where water or hydraulic fluid can spill during maintenance or repair procedures.</p>
	<p>Keep spare parts and repair kits available.</p>

Normal status

Pump starting

Refer to **Start the pump** on page 61 for information about the start sequence.

Operator interface	Beacon light	Intensifier	Primary motor
Primary operation screen with the start sequence progress bar	Green, flashing	Enabled	On

Pump on

Operator interface	Beacon light	Intensifier	Primary motor
Primary operation screen	Green, not flashing	Enabled	On

Alarms

The controller monitors the pump while the pump is operating. When the controller senses a problem that is likely to cause damage to the equipment, the operator interface shows an **Alarms** screen and the beacon light flashes.



Operator interface	Beacon light	Intensifier	Primary motor	Cause
Warning	Amber, flashing	Enabled	On	The controller senses a condition that can cause a problem or a failure.
Fault 1	Red, flashing	Off	On, pump is in cooling mode	The controller senses a condition that will cause a problem or a failure.
Fault 2	Red, flashing	Off	Off	The controller senses a failure condition.
Fault 3	Red, flashing	Enabled	On	The Seal Maintenance Indicator (SMI) senses a seal failure condition.

7 – Troubleshooting

To acknowledge an alarm, touch the screen. It changes to an interactive screen.

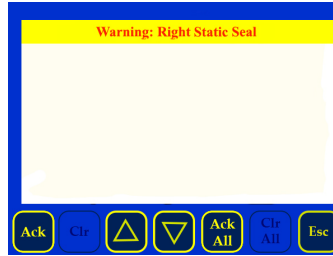

Touch **Ack** (acknowledge) or **Ack All** (acknowledge all) on the screen. The beacon light stops flashing and the alarm screen closes.

Warnings

Warning: Battery Error

The controller battery is not operating correctly.

Contact a Hypertherm Technical Service Associate for information and support.

Warning: Boost Motor **Warning: Fan Motor**

The boost motor or the fan motor did not start because the thermal overload relay has tripped.



Tripped position



On position



Off position

Reset the relay.

4. Find the thermal overload relay on the motor starter.
5. Turn the knob clockwise to the ON position (I).
6. Release the knob. It snaps counterclockwise to the OFF position (O).
7. Turn the knob clockwise to the ON position (I) again.

Warning: Empty the Dirty Water Container

The dirty water container is full.

Empty the container. Refer to step 1 of **Examine and clean the equipment** on page 76.

7 – Troubleshooting

Warning: Fluid Monitoring is Disconnected

The SMI is not plugged in.

Make sure that the SMI cable harness is not damaged and that the connections are not loose.

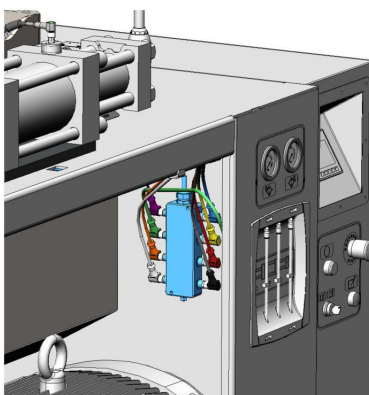

The cable harness connects to the junction box (shown) and to the back of the SMI.

The SMI is damaged.

Replace the SMI. Contact a Hypertherm Technical Service Associate for information and support.

A tube is dirty.

Warning: Fluid Monitoring Sensor Error

- Clean the tubes. Refer to **Clean the Seal Maintenance Indicator tubes** on page 89.
- Replace the tubes.

An object is blocking the optical sensor.

Remove the object.

An optical sensor is damaged.

Replace the SMI. Contact a Hypertherm Technical Service Associate for information and support.

Warning: Hydraulic Fluid >55C

The hydraulic fluid is too hot.

Refer to **Temperature** on page 162.

Warning: Start Procedure Hydraulics

An error occurred during stage 3 of the start sequence.

- Make sure that the cutting head is turned off.
- Adjust the Hydraulics timer on the Start-procedure Timers screen. Refer to **Start-procedure Timers** on page 219.

7 – Troubleshooting

Warning: Start Procedure Ramp to Pierce Pressure

An error occurred during stage 4 of the start sequence.

- Make sure that the cutting head is off.
- Adjust the Pierce timer on the Start-procedure Timers screen. Refer to **Operate the pump** on page 60.

Warning: Start Procedure Ramp to Cut Pressure

An error occurred during stage 5 of the start sequence.

- Make sure that the cutting head is turned off.
- Adjust the Cut timer on the Start-procedure Timers screen. Refer to **Operate the pump** on page 60.

Warning: Too Many Motor Starts in 15 Minutes

Starting and stopping the motor rapidly can cause damage to the motor.

Wait longer between stopping and starting the motor.

Warning: Left Dynamic Seal
Warning: Right Dynamic Seal
Warning: Left Static Seal
Warning: Right Static Seal

The SMI senses that the high-pressure seal life remaining is between 8 hours and 50 hours.

Replace the seal. Refer to **Water** on page 166.

7 – Troubleshooting

Faults

Fault 1: Hydraulic Fluid >65C

The hydraulic fluid is too hot.

Refer to **Temperature** on page 162.

Fault 1: Intensifier 1 Overstroke to Left
Fault 1: Intensifier 1 Overstroke to Right

The intensifier is overstroking.

Refer to **The intensifier overstrokes in 1 direction** on page 158.

Fault 1: Low Inlet Water Pressure

The water pressure at the manifold is lower than the minimum setting.

The supply pressure is lower than 2.8 bar (280 kPa / 40 psi).

Increase the supply pressure.

Pressure is lost because of a leak.

Identify the source of a leak and correct the problem.

The supply water is turned off.

Turn ON the supply water.

Fault 2: Hydraulic Fluid >65C for >3 Minutes

The hydraulic fluid is too hot.

Refer to **Temperature** on page 162.

Fault 2: Hydraulic Fluid 45C Sensor

The temperature sensor in the hydraulic fluid tank has failed.

Replace the sensor.

Fault 2: Hydraulic Fluid Level is Low

The float switch in the hydraulic fluid tank monitors the fluid level.

A hydraulic fitting or a hydraulic hose is leaking.

Fix the leak. Refer to **Leaks** on page 165.

7 – Troubleshooting

Fault 2: Input to Primary Motor Not Received

The controller did not receive a signal from the starter when the pump was turned on.

- If the soft starter fault light is on, look for loose wires.
- Make sure the contactor on the starter is operating correctly.

Fault 2: Primary Motor

The primary motor did not start.

HyPrecision P-15/P-30/P-50 – The thermal overload relay has tripped.

An overcurrent condition causes the thermal overload relay to become hot. When it becomes too hot, the relay trips. The relay must cool before it can be started again.

Push the blue button to reset the relay.



The relay can take some time to cool before resetting.

HyPrecision P-50S/P-60S/P-75S – The soft starter sensed a fault.

1. Turn the primary breaker disconnect lever on the electrical enclosure door to OFF.

The pump is not energized.

2. Turn the primary breaker disconnect lever on the electrical enclosure door to ON.

The pump is energized.



It can take some time for the system to reboot.

A fuse in the electrical enclosure has blown.

Replace the blown fuse.

The relief valve on the pump manifold has failed.

Contact a Hypertherm Technical Service Associate for information and support.

Fault 2: Water Pressure Control Error

The pump does not get to the target pressure within the expected time. The hydraulic pressure transducer on the pump manifold has failed.

The pressure control valve on the pump manifold has failed.

The relief valve on the pump manifold has failed.

The hydraulic compensator on the pump has failed.

Contact a Hypertherm Technical Service Associate for information and support.

Fault 2: Left Dynamic Seal

Fault 2: Right Dynamic Seal

Fault 2: Left Static Seal

Fault 2: Right Static Seal

Fault 3: Left Dynamic Seal

Fault 3: Right Dynamic Seal

Fault 3: Left Static Seal

Fault 3: Right Static Seal

The SMI senses an imminent high-pressure seal failure.

Replace the seal. Refer to **Water** on page 166.

Intensifier problems

Intensifier control

If intensifier control is turned off, the primary screen shows an X on the intensifier symbol.

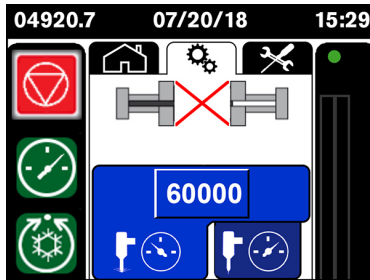

Refer to **Intensifier Control** on page 223.

Stroking

Overstroke

The motor's wattage and the size of the hydraulic pump determine the maximum intensifier stroke rate.

It is normal for the intensifier to stroke faster during the start sequence and when changing from low pressure to high pressure. During normal operation, the intensifier should stroke smoothly to the left and right at the same speed. An overstroke fault occurs when the hydraulic piston travels faster than the pump can sustain.

An overstroke alarm is caused by 3 conditions:

- Overstroking to the left (Fault 1: Intensifier 1 Overstroke to Left)
- Overstroking to the right (Fault 1: Intensifier 1 Overstroke to Right)
- Overstroking in both directions

If an overstroke alarm shows on the operator interface:

1. Turn OFF the cutting head.
2. Acknowledge the alarm.
3. Put the pump in cut-pressure mode. The intensifier starts stroking.
4. Turn ON the cutting head.
5. Monitor the intensifier stroke rate indicator on the operator interface.

The intensifier overstrokes in 1 direction

A poppet is sticking, worn, or damaged.

Overstroking to the left can be caused by:

- The low-pressure poppet on the left side of the intensifier has failed.
- The high-pressure poppet on the right side of the intensifier has failed.

Overstroking to the right can be caused by:

- The low-pressure poppet on the right side of the intensifier has failed.
- The high-pressure poppet on the left side of the intensifier has failed.

Low-pressure poppet or check valve

- Examine the face of the poppet and the mating face on the check valve. Make sure that the faces are smooth and flat and have an almost mirrored finish. Refer to **Repair the check valves and the low-pressure poppets** on page 105.
- Repair or replace the low-pressure poppet.
- Make sure that the low-pressure poppet fits in the poppet basket without sticking.
- Repair or replace the check valve.

High-pressure poppet

- Replace the high-pressure poppet, the spring, and the seat.
- Monitor the temperature of the output adapter on the intensifier end opposite the direction of overstroke. If the output adapter is hot, remove it from the check valve and examine the high-pressure poppet, the spring, and the seat.

The intensifier overstrokes in both direction

The orifice is worn, has failed, or is incorrectly installed.

A worn or damaged orifice can increase the demand for high-pressure water from the intensifier. Replace the orifice.

The high-pressure water seals are worn or damaged.

Replace the high-pressure water seals.

The high-pressure tubing or a fitting is leaking.

Identify the source of a leak and correct the problem.

The bleed-down valve is leaking.

Repair or replace the bleed-down valve.

The needle and the seat in the cutting head are leaking.

- Repair or replace the cutting head.
- Repair or replace the on/off valve.
- Replace the needle and the seat.

The low-pressure water relief valve is venting water to the drain.

Remove the 3/8-inch tube from the valve at the outlet fitting and monitor for leaks.

The postfilter water-pressure gauge shows that the low-pressure water is lower than 2.8 bar (280 kPa / 40 psi).

Replace the water filters if the difference between the values on the prefilter water-pressure gauge and the postfilter water-pressure gauge is lower than 0.7 bar (70 kPa / 10 psi).

The prefilter water-pressure gauge shows that the low-pressure water is lower than 2.8 bar (280 kPa / 40 psi).

- The intensifier can starve for water without starting the low-pressure alarm for the low-pressure water.
- Make sure that the water to the pump is turned on.
- While the pump is operating, make sure that the LED on the low-pressure water drain valve solenoid is on. The light shows that the solenoid is closed.
- Make sure that the low-pressure water is connected to the intensifier.
- Examine the 10-micron water filter. If the filter is black, the boost pump has failed and must be replaced. Contact a Hypertherm Technical Service Associate for information and support.

7 – Troubleshooting

Change the overstroke %

Overstroke % is the increased stroke rate that is permitted before an overstroke fault condition occurs.

HyPrecision pump model	Maximum strokes/minute
P-15	26
P-30	52
P-50 and P-50S	84
P-60S	90
P-75S	100

Default overstroke percentage = 5%

Maximum overstroke percentage = 20%

Contact a Hypertherm Technical Service Associate for information and support.

Other stroking problems

The intensifier does not stroke to either side

The intensifier is not enabled.

Make sure that the intensifier is enabled. Refer to **Intensifier Control** on page 223.

The cutting head is turned off.

Turn ON the cutting head.

A proximity switch has failed.

An indicator spring is broken or damaged.

An indicator pin is stuck.

If the amber lights are on at the same time, a proximity switch might have failed, an indicator spring might be broken, or an indicator pin might be stuck. Examine all parts to find the cause of the fault.

A proximity switch cord has failed.

Examine the cords on the proximity switches for damage.

The intensifier strokes to 1 side and then stalls on the same side

A proximity switch has failed.

- Interchange the proximity switches (but not the wires). If the intensifier stalls on the opposite end, replace the proximity switches.
- Examine the indicator pin for burrs. The pins should move easily to the bottom of the bore.
- Make sure that the indicator pin springs are not broken and that they are the same length.

A shift pin is damaged.

While the pump is in cooling mode, push on the shift pin on the stalled side. The shift pin is found at the ends of the coil on the pilot valve.

- If the intensifier strokes to other side, the problem is electrical.
- If the intensifier does not move, the problem is mechanical.

The intensifier strokes but there is not enough pressure at the cutting head

The thimble filter on the on/off valve is defective.

Repair or replace the thimble filter.

There is a blockage in the high-pressure tubing.

Remove the blockage from the high-pressure tubing.

There is a problem in the high-pressure end.

- Check the temperature of the output adapter. If it is hot, examine the high-pressure poppet and the high-pressure poppet seat.
- Check the temperature of the bleed-down valve. If it is hot or if water is coming out of the drain hose, repair or replace the bleed-down valve.
- Check the temperature of the high-pressure cylinders. If 1 is hot, disassemble it and look for flaws, deterioration, erosion marks, or cracks in the parts, including the check valve and piston seal.

The orifices are not the correct size or too many are being used.

Make sure that the number of orifices and their sizes are sufficient for the pump's output.

A hydraulic piston seal is worn or damaged.

Contact a Hypertherm Technical Service Associate for information and support.

High-pressure water seal life is short

- Make sure that the mating surfaces are smooth and clean.
- Repair or replace the high-pressure cylinder and plunger.
- Make sure that the water quality is within satisfactory ranges. Refer to the **Water quality** section, which begins on page 188.
- Examine the ends of the high-pressure cylinder for cracks.
- Replace the high-pressure water seals and hoops.
- Check the air pressure in the water accumulator tank. Refer to **Measure the air pressure in the water accumulator tank** on page 92 for instructions.
- Replace the high-pressure cylinder.
- Make sure the proportional control is operating correctly.
- Make sure that the flow and water pressure are sufficient.

If the high-pressure seal backups have a short life, make sure that the plunger bearing is not worn.

Instructions about how to disassemble the intensifier and how to repair or replace parts start on page 97.

Hydraulic fluid

Temperature

The cooling water temperature is too high

Water-cooled system

The cooling water is not turned on.

Turn ON the cooling water

The cooling water is too warm.

If the cooling water or the supply water temperature is higher than 24.0°C (75°F), cool the water before use. Water that is too warm is not good for cooling and can shorten high-pressure seal life.

Air-cooled system



Do not adjust the setting on the thermal overload relay unless instructed to do so by a Hypertherm Technical Service Associate.

The ambient temperature is too high.

Consider supplemental cooling.

The fan is not generating enough airflow.

- Make sure that the fan motor breaker is not tripped.
- Make sure that the heat exchanger fins are not dirty or clogged.

The thermal overload relay turned off the fan motor.

Refer to page 157.

7 – Troubleshooting

All systems

High altitude and ambient temperatures can have an effect on the temperature of hydraulic fluid. Fluid that is too cool is thick and causes increased friction and poor lubrication. Fluid that is too hot is thin, which accelerates wear on the parts, increases the formation of sludge, degrades the fluid, and decreases its lubrication and protective qualities.

Increased temperature can mean that there is a problem with the cooling system.

A sensor monitors the hydraulic fluid temperature in the tank.

The sensor is not sensing the correct temperature

The cord for the hydraulic fluid temperature/level sensor is unplugged or damaged.

- Plug in the sensor.
- Replace the cord.

The temperature sensor is faulty or damaged.

Replace the sensor.

The operator interface shows a hydraulic fluid temperature alarm

When the hydraulic fluid temperature is 55°C (131°F):

- At 45°C (113°F), a switch closes to start the cooling fan.
- The operator interface shows **Warning: Hydraulic Fluid >55C**.
- The beacon light flashes amber.
- The fan operates for 10 minutes.

If the hydraulic fluid temperature is lower than 55°C (131°F) after 10 minutes, the fan turns off.

If the hydraulic fluid temperature is higher than 45°C (113°F) after 10 minutes, the fan continues operating.

When the hydraulic fluid temperature is 65°C (149°F):

- The operator interface shows **Fault 1: Hydraulic Fluid >65C**
- The beacon light flashes red.
- The intensifier turns off.
- The pump operates in cooling mode for 3 minutes.

If the temperature remains at or higher than 65°C (149°F):

- The operator interface shows **Fault 2: Hydraulic Fluid >65C for >3 Minutes**
- The primary motor turns off.

Pressure

The hydraulic fluid pressure is too low

There is a leak.

Examine the pump for hydraulic fluid leaks. Monitor these areas:

- Hydraulic fluid tank access cover
- Hydraulic connections
- Valves
- Top and bottom decks

The hydraulic fluid level is too low.

Make sure that the hydraulic fluid level is at the top mark on the sight gauge.

Add hydraulic fluid, if necessary.

The cut pressure is not set correctly.

Make sure that the cut pressure is set correctly.

The pump is in pierce-pressure mode.

Make sure that the pump is in cut-pressure mode.

The relief valve on the pump manifold has failed.

Check the relief valve. Contact a Hypertherm Technical Service Associate for information and support.

Level

A float switch in the hydraulic fluid tank causes an alarm when the hydraulic fluid level is too low.

The hydraulic fluid level is too low

A hydraulic fitting or a hydraulic hose is leaking.

Refer to **Leaks** on page 165.

Hydraulic fluid was lost during maintenance.

Add hydraulic fluid. Refer to **Add hydraulic fluid** on page 82.

Leaks

A leaking high-pressure seal in the intensifier can push water past the rod seal and into the hydraulic fluid. Hydraulic fluid contaminated with water has a milky appearance. Contaminated hydraulic fluid can cause damage to the hydraulic pump.

Replace the hydraulic fluid and examine all of the parts, including the inner surfaces of the hydraulic fluid tank, the hydraulic hoses, and the seals. Refer to page 81 for instructions.

It could be necessary to drain and flush other areas such as the shift valve, the hydraulic manifolds, and the hydraulic pump.

SMI-related alarms are described in detail starting on page 173.

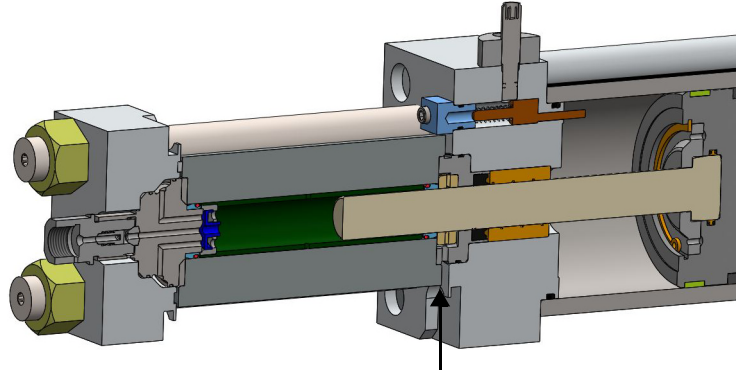

Refer to **Seal Maintenance Indicator** on page 222.

The rod seal has failed.

The O-ring or O-ring backup on the seal housing has failed.

Replace the component.

Hydraulic fluid leaks from anywhere on the intensifier

An O-ring has failed.

Replace the component.

Water leaks into the heat exchanger

In water-cooled systems, water can enter the hydraulic system through the heat exchanger.

If this occurs, contact a Hypertherm Technical Service Associate for information and support.

Water

Pressure

The supply water pressure is too low

A pressure transducer in the water manifold senses the supply water pressure. If the value on the prefilter water-pressure gauge is lower than 2.8 bar (280 kPa / 40 psi), the water pressure going to the intensifier is too low. When the pressure is at a value that is lower than the setpoint, the monitoring circuit opens and causes a fault.

The orifice is defective.

Replace the orifice.

There is a leak.

Make sure that the intensifier does not stroke when it is in cut-pressure mode with the cutting head turned off. If it does stroke, check the bleed-down valve and the high-pressure tubing for leaks.

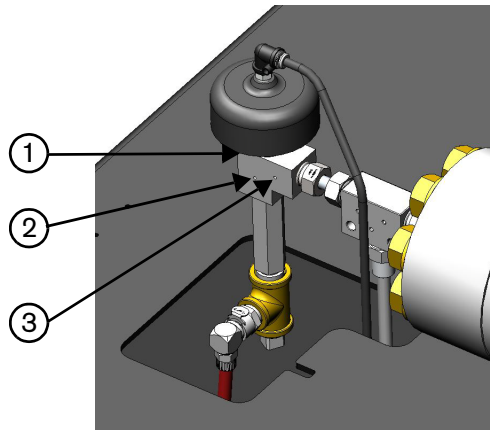

- 1 A leak from here can mean a problem with the seal in the bleed-down valve.
- 2 A leak from here can mean an unsatisfactory connection between the bleed-down valve and the high-pressure tubing.

- 3 A leak from here can mean a problem with the bleed-down valve needle and seat.

A check valve is damaged.

Examine the check valves. Repair or replace them, if necessary.

The pump is in pierce-pressure mode or is set incorrectly.

Put the pump in cut-pressure mode. Make sure that the cut pressure is set correctly. Refer to **Pierce-pressure mode and cut-pressure mode** on page 59.

The supply water is not turned on.

Turn ON the supply water.

A water filter is clogged.

Replace the water filters.

The relief valve on the pump manifold has failed.

Contact a Hypertherm Technical Service Associate for information and support.

7 – Troubleshooting

The boost pump has failed.

- HyPrecision P-15/P-30/P-50: Examine the 1.0-micron water filter.
- HyPrecision P-50S/P-60S/P-75S: Examine the 10-micron water filter.

If the filter is black, the boost pump has failed and must be replaced. Contact a Hypertherm Technical Service Associate for information and support.

The supply water pressure is too high

If the value on the prefilter water-pressure gauge is higher than 7.9 bar (790 kPa / 115 psi), the water pressure is too high.

The value on either water-pressure gauge is higher than 8.6 bar (860 kPa / 125 psi).

Contact a Hypertherm Technical Service Associate for information and support.

The boost pump is not needed.

The pump's low-pressure water parts are rated for a maximum pressure of 8.6 bar (860 kPa / 125 psi). In environments with high supply water pressure, the boost pump can increase the water pressure to higher than the maximum. This can cause damage to the filters and other parts.

If the value on the prefilter water-pressure gauge is higher than 4.8 bar (480 kPa / 70 psi):

1. In the electrical enclosure, turn the switch on the boost pump motor contactor to 0.
2. On the operator interface, turn off the boost pump monitoring. Refer to **Pump Adjustments** on page 218.

The boost pump bypass relief valve is not adjusted correctly.

Contact a Hypertherm Technical Service Associate for information and support.

A water filter is clogged.

Replace the water filters.

The intensifier water pressure is too low

A pressure transducer in the water manifold senses the supply water pressure. If the pressure decreases to a value that is lower than the setpoint, the monitoring circuit opens and causes a fault.

There is a leak.

- Identify the source of a leak and correct the problem.
- If the intensifier strokes when it is in cut-pressure mode with the cutting head turned off, check the bleed-down valve and the high-pressure tubing for leaks.

A poppet is sticking, worn, or damaged.

Low-pressure poppet

- Examine the face of the poppet and the mating face on the check valve. Make sure that the faces are smooth and flat and have an almost mirrored finish. Refer to **Repair the check valves and the low-pressure poppets** on page 105.
- Repair or replace the low-pressure poppet.
- Make sure that the low-pressure poppet fits in the poppet basket without sticking.
- Repair or replace the check valve.

High-pressure poppet

Replace the high-pressure poppet, the spring, and the seat.

7 – Troubleshooting

Leaks



Identify the source of a leak and correct the problem.
A leak can cause damage to the water fittings.

If a fitting leaks after tightening it to the maximum torque value, disassemble the parts. Repair or replace parts that show deterioration, corrosion, or damage.

The high-pressure water seals and hoops are damaged

Damage to the high-pressure water seals and the hoops is the most common cause of water leaking from the intensifier. Water dripping from the high-pressure cylinder shows that seal replacement will soon be necessary.

Replace the damaged parts.

Tubing or fittings are leaking

Make sure that the tubing, the water fittings, and the quick disconnects are not leaking.
Make sure that some of the threads on the high-pressure tubing are visible at the fitting.

Water leaks onto the floor or into the pump frame

The dirty water container is full.

Empty the container. Refer to step 1 of **Examine and clean the equipment** on page 76.

The dirty water container is missing or misaligned.

Replace or move the container.

The transport tubes or SMI tube are disconnected

Check the transport tube and the SMI tube routing.

Water leaks from a weep hole in the dynamic seal backup or the seal housing

Weep holes throughout the high-pressure water system let water escape from leaking parts. A leak can mean that there is a faulty part, a loose fitting, or a damaged seat.

Blocked weep holes in the dynamic seal backup or the seal housing cause water to go into the hydraulic system.

Make sure that the weep holes are clean.

Water leaks from an output adapter weep hole

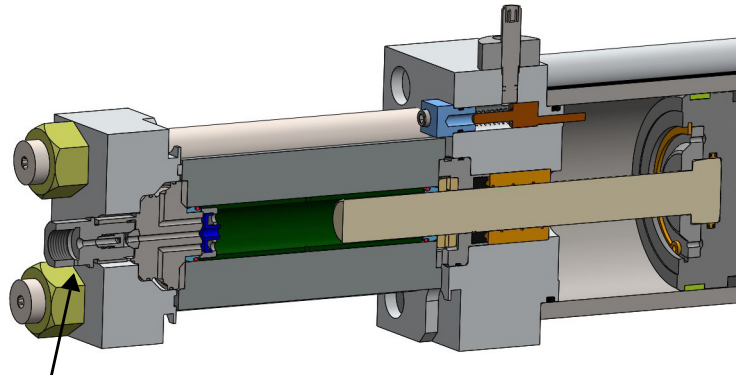

A fitting on the high-pressure tubing is not tight enough.

Tighten the fitting.

Make sure that some of the threads on the high-pressure tubing are visible at the fitting.

The tube end is cracked or damaged.

The output adapter has failed.

Replace the component.

Water leaks from a high-pressure seat weep hole

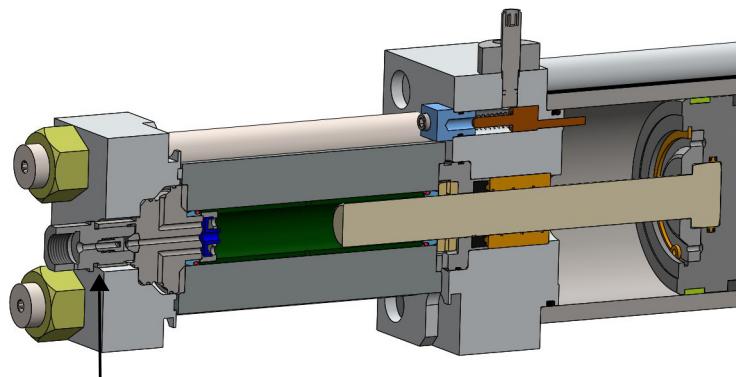

The output adapter is loose.

Tighten the adapter.

The high-pressure poppet seat has failed.

The seat face of the check valve is cracked.

If the leaking water is hot, replace the seat and poppet.

The O-rings on the check valve body have failed.

If the leaking water is cool, replace the O-rings.

7 – Troubleshooting

Water leaks from a static seal leak point

Refer to **Seal Maintenance Indicator (SMI)** on page 171.

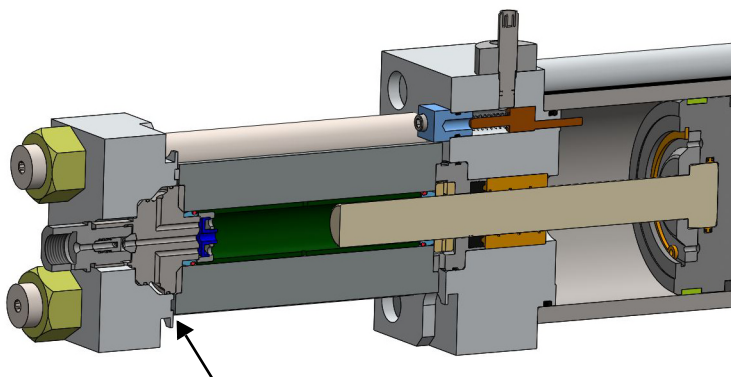

A high-pressure seal has failed.

The check valve O-ring nearest to the high-pressure seal has failed.

Replace the component.

Water leaks from the dynamic seal housing weep hole

Refer to **Seal Maintenance Indicator (SMI)** on page 171.

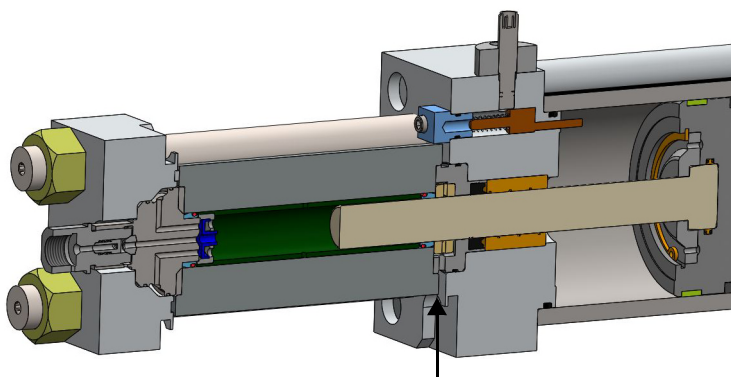

A high-pressure seal has failed.

Replace the seal.

Seal Maintenance Indicator (SMI)

Fluid leaking from a weep hole is a sign of a faulty part or a loose connection. The SMI monitors the rate of drops from the static seal and the dynamic seal.

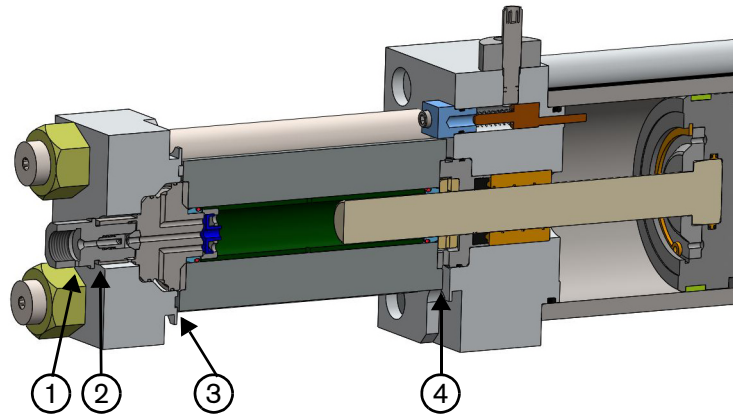

- | | |
|----------------------------------|----------------------------|
| 1 Output adapter leak | 3 Static seal leak |
| 2 High-pressure seat leak | 4 Dynamic seal leak |

 Static seal: The high-pressure seal at the output end of the high-pressure cylinder

 Dynamic seal: The high-pressure seal that is nearest the hydraulic center section

Operator interface

Operation screen

When the quantity of fluid leaking from the intensifier is less than a set threshold, the intensifier symbol on the primary operation screen is in its usual state.

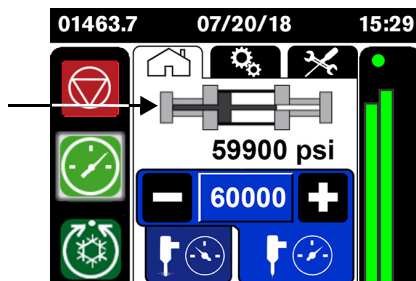

Alarms

SMI-related alarms are described here. All other alarms are described starting on page 152.

The controller monitors the pump while it is operating. When the controller senses a problem that is likely to cause damage to the equipment, the operator interface shows an **Alarms** screen and the beacon light flashes.



Alarm screen on the operator interface	Beacon light	Intensifier	Primary motor	Cause
Warning	Amber, flashing	Enabled	On	The SMI senses that the seal life remaining is between 8 hours and 50 hours.

7 – Troubleshooting

If the drip rate increases, a fault occurs.

Alarm screen on the operator interface	Beacon light	Intensifier	Primary motor	Cause
Fault 2	Red, flashing	Not enabled	<p>Stop On Fault is enabled The pump operates for 30 minutes, then the primary motor turns off.</p> <p>Stop On Fault is not enabled The pump continues operating.</p>	The SMI senses imminent seal failure.
Fault 3	Red, flashing	Enabled	<p>Stop On Fault is enabled The pump continues operating.</p> <p>Stop On Fault is not enabled The pump operates for 2 hours, then the fault alarm shows on the screen.</p>	The SMI senses imminent seal failure.

Refer to **Seal Maintenance Indicator** on page 222 for information about the Stop On Fault feature and adjusting timer values.

After the alarm is acknowledged, a box on the intensifier symbol shows where the leaking seal is. A yellow box with a 1 in it means that it is a warning. A red box with a 2 in it means that it is a fault.

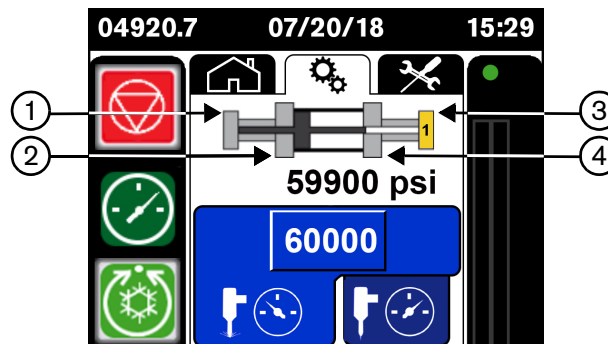

- | | |
|---------------------|----------------------|
| 1 Left static seal | 3 Right static seal |
| 2 Left dynamic seal | 4 Right dynamic seal |

Replace the seal. Refer to **High-pressure water system: Intensifier** on page 97.

If the RUN symbol is touched after a fault condition, the **Seal Change** screen shows on the operator interface.

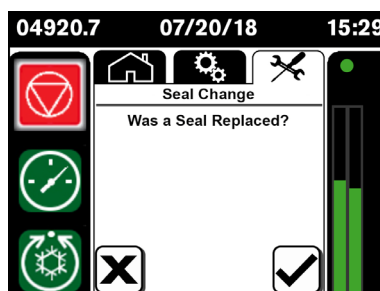

- Touch the ✓ symbol to acknowledge that a seal was replaced.
- Touch the X symbol to close the screen. The fault alarm shows on the screen after 2 hours.

A warning or a fault occurs during the start sequence

The start sequence timers are adjustable. Refer to **Start-procedure Timers** on page 219 for information. Refer to **Start the pump** on page 61 for a description of the start sequence and problems that can occur.

The pump makes noise during operation

If air is in the hydraulic system, the pump can be noisy during operation.

1. Use a 13-mm socket or wrench to tighten the hose clamps on the suction hose that goes from the hydraulic fluid tank to the bottom of the hydraulic pump.

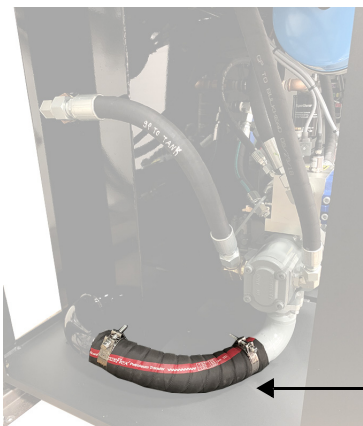

HyPrecision P-15/P-30/P-50 pump

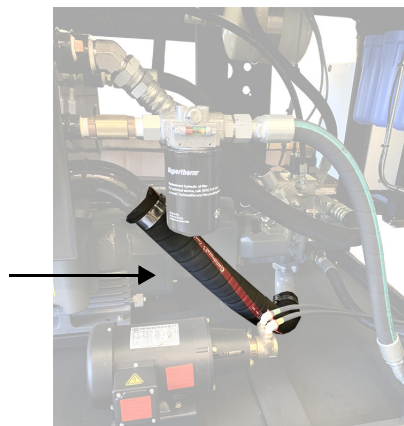

HyPrecision P-50S/P-60S/P-75S pump

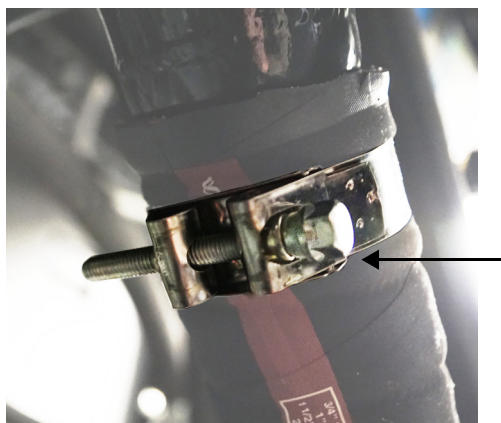

2. Torque the hose clamps to a maximum of 29 N·m (22 lbf·ft).

If the pump is still noisy after tightening the hose clamps, contact a Hypertherm Technical Service Associate for information and support.

Controller problems

Input/output status

This screen shows all inputs and outputs on the controller. Green shows enabled status. Gray shows not enabled status. These can be helpful for troubleshooting.

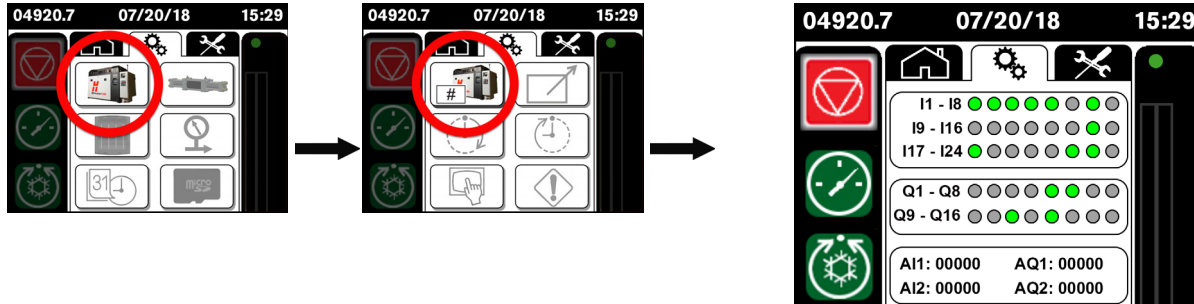

This table describes the assigned inputs and outputs.

I1	Hydraulic fluid level
I2	Hydraulic fluid temperature is higher than 55°C (131°F)
I3	Hydraulic fluid temperature is higher than 65°C (149°F)
I4	Hydraulic fluid temperature is higher than 45°C (113°F)
I5	Not used
I6	Front intensifier left proximity switch
I7	Front intensifier right proximity switch
I8	Not used
I9	SMI address 0
I10	SMI address 1
I11	SMI operating out
I12	SMI fault
I13	Not used
I14	Not used
I15	Controls on
I16	Remote mode on
I17	Remote pump on
I18	Remote pump off
I19	Remote cooling on
I20	Remote pierce-pressure on
I21	Primary motor fault
I22	Primary motor on
I23	Boost pump on
I24	Heat exchanger fan on

7 – Troubleshooting

Q1	Low-pressure on
Q2	Proportional control output
Q3	Low-pressure dump valve
Q4	Pump on
Q5	Fan motor on
Q6	Enable bleed-down valve
Q7	Front left shift valve solenoid
Q8	Front left shift valve solenoid
Q9	Beacon light - amber
Q10	Supply cooling water
Q11	Reset remote
Q12	Primary motor on
Q13	Boost pump motor on
Q14	Remote fault light
Q15	Beacon light - red
Q16	Beacon light - green
AI1	Hydraulic pressure
AI2	Remote pressure control
AQ1	Not used
AQ2	Not used

Section 8

Pump specifications

In this section

- Optimal environmental conditions
- Hydraulic fluid information
- Utility requirements
- Model-specific specifications
- Orifice information
- Torque values for fasteners and fittings

All HyPrecision pump models

Environmental conditions

Ambient operating temperature	4.4°C to 35.0°C (40°F to 95°F)
Relative humidity Noncondensing	95%
Storage temperature Water not drained	1.7°C to 55.0°C (35°F to 131°F)

If the cooling water or the supply water temperature is higher than 24.0°C (75°F), cool the water before use. Water that is too warm is not good for cooling and can shorten high-pressure seal life.

Hydraulic fluid

Domestic pumps ship from the factory with AW 32 hydraulic fluid.

Type	Antiwear (AW) mineral oil or synthetic hydraulic fluid, ISO viscosity grade (VG) 32 or 46
Tank capacity	150 L (40 gallons) If the pump is air-cooled, increase the hydraulic fluid volume to fill the hoses and the heat exchanger.
Normal operating temperature	37.8°C to 43.3°C (100°F to 110°F)
Maximum pressure Set at the factory	224 bar (22,400 kPa / 3,250 psi)

High altitude and ambient temperatures can have an effect on the temperature of hydraulic fluid. Fluid that is too cool is thick and causes increased friction and poor lubrication. Fluid that is too hot is thin, which accelerates wear on the parts, increases the formation of sludge, degrades the fluid, and decreases its lubrication and protective qualities.

Utilities

Electrical power

The motor size determines the full load amperes, the overload settings, and the wire sizes. Refer to your pump model (starting on page 180 in this section) or to the system schematic drawing.

Supply water

The quality of the water supplied to the intensifier has a direct effect on the life of the intensifier and consumables. Bad water quality increases operating costs by causing unnecessary wear on pump parts and shortening maintenance intervals. Mineral deposits can clog the cooling fins in the heat exchanger.

Softened water is necessary for most systems. Get advice from a specialist for recommendations for choosing a water treatment system. Reverse osmosis systems are available from Hypertherm.

Total dissolved solids (TDS)

Dissolved solids cause deposits that can cause damage to check valves, seals, orifices, and other consumables. Refer to the table on page 96 for recommended TDS levels.

8 – Pump specifications

Compressed air

	Minimum	Maximum
Flow	4.8 bar (70 psi)	5.5 bar (80 psi)

Air pressure that is too low can prevent the bleed-down valve from closing and can cause the intensifier to overstroke.

Air pressure that is too high can cause damage to the needle and the seat in the bleed-down valve.

HyPrecision P-15

Dimensions and weights

Length	178 cm (70 in.)	Shipping weight	1,100 kg (2,400 lb)
Width	86 cm (34 in.)	Operating weight	1,000 kg (2,200 lb)
Height	140 cm (55 in.)		

The shipping weight is for the pump, the pallet, and the packaging. Exact weights are measured at shipment. Operating weight is for an unpackaged pump with hydraulic fluid.

Electrical

11 kW, 15 hp	50 Hz	60 Hz	
Voltage	400 V	208 V to 230 V	460 V
Full-load current	24.9 A	45.8 A to 41.6 A	20.8 A
Primary circuit breaker rating	25.0 A	50.0 A	25.0 A

The pump uses 3-phase alternating current (AC) electricity. Some parts, such as valve solenoids and sensors, use 24-volt direct current (VDC) electricity from a power supply in the electrical enclosure.

Water

	Minimum	Maximum
CUTTING WATER IN		
Flow	3.8 L/minute (1 gallon/minute)	—
Pressure	2.8 bar (280 kPa / 40 psi)	7.6 bar (760 kPa / 110 psi)
CUTTING WATER OUT		
Flow	—	1.1 L/minute (0.3 gallon/minute)
Pressure	345 bar (34,500 kPa / 5,000 psi)	4,140 bar (414,000 kPa / 60,000 psi)
Cut pressure factory setpoint	—	4,140 bar (414,000 kPa / 60,000 psi)
Pierce pressure factory setpoint	1,380 bar (138,000 kPa / 20,000 psi)	—
COOLING IN and COOLING OUT		
Flow	11.4 L/minute (3 gallons/minute)	—
Pressure	2.8 bar (280 kPa / 40 psi)	7.6 bar (760 kPa / 110 psi)

8 – Pump specifications

HyPrecision P-30

Dimensions and weights

Length	178 cm (70 in.)	Shipping weight	1,200 kg (2,600 lb)
Width	86 cm (34 in.)	Operating weight	1,100 kg (2,400 lb)
Height	140 cm (55 in.)		



The shipping weight is for the pump, the pallet, and the packaging. Exact weights are measured at shipment. Operating weight is for an unpackaged pump with hydraulic fluid.

Electrical

22 kW, 30 hp	50 Hz	60 Hz	
Voltage	400 V	208 V to 230 V	460 V
Full-load current	46.9 A	84.9 A to 77.0 A	38.5 A
Primary circuit breaker rating	50.0 A	200.0 A	50.0 A

The pump uses 3-phase alternating current (AC) electricity. Some parts, such as valve solenoids and sensors, use 24-volt direct current (VDC) electricity from a power supply in the electrical enclosure.

Water

	Minimum	Maximum
CUTTING WATER IN		
Flow	4.5 L/minute (1.2 gallons/minute)	—
Pressure	2.8 bar (280 kPa / 40 psi)	7.6 bar (760 kPa / 110 psi)
CUTTING WATER OUT		
Flow	—	2.3 L/minute (0.6 gallon/minute)
Pressure	345 bar (34,500 kPa / 5,000 psi)	4,140 bar (414,000 kPa / 60,000 psi)
Cut pressure factory setpoint	—	4,140 bar (414,000 kPa / 60,000 psi)
Pierce pressure factory setpoint	1,380 bar (138,000 kPa / 20,000 psi)	—
COOLING IN and COOLING OUT		
Flow	11.4 L/minute (3 gallons/minute)	—
Pressure	2.8 bar (280 kPa / 40 psi)	7.6 bar (760 kPa / 110 psi)

HyPrecision P-50

Dimensions and weights

Length	178 cm (70 in.)	Shipping weight	1,250 kg (2,800 lb)
Width	86 cm (34 in.)	Operating weight	1,200 kg (2,600 lb)
Height	140 cm (55 in.)		

The shipping weight is for the pump, the pallet, and the packaging. Exact weights are measured at shipment. Operating weight is for an unpackaged pump with hydraulic fluid.

Electrical

37 kW, 50 hp	50 Hz	60 Hz	
Voltage	400 V	208 V to 230 V	460 V
Full-load current	73.8 A	138.2 A to 125.8 A	62.9 A
Primary circuit breaker rating	80.0 A	150.0 A	80.0 A

The pump uses 3-phase alternating current (AC) electricity. Some parts, such as valve solenoids and sensors, use 24-volt direct current (VDC) electricity from a power supply in the electrical enclosure.

Water

	Minimum	Maximum
CUTTING WATER IN		
Flow	7.6 L/minute (2 gallons/minute)	—
Pressure	2.8 bar (280 kPa / 40 psi)	7.6 bar (760 kPa / 110 psi)
CUTTING WATER OUT		
Flow	—	3.8 L/minute (1 gallon/minute)
Pressure	345 bar (34,500 kPa / 5,000 psi)	4,140 bar (414,000 kPa / 60,000 psi)
Cut pressure factory setpoint	—	4,140 bar (414,000 kPa / 60,000 psi)
Pierce pressure factory setpoint	1,380 bar (138,000 kPa / 20,000 psi)	—
COOLING IN and COOLING OUT		
Flow	11.4 L/minute (3 gallons/minute)	—
Pressure	2.8 bar (280 kPa / 40 psi)	7.6 bar (760 kPa / 110 psi)

HyPrecision P-50S

Dimensions and weights

Length	196 cm (77 in.)	Shipping weight	1,350 kg (3,000 lb)
Width	97 cm (38 in.)	Operating weight	1,300 kg (2,800 lb)
Height	155 cm (61 in.)		

The shipping weight is for the pump, the pallet, and the packaging. Exact weights are measured at shipment. Operating weight is for an unpackaged pump with hydraulic fluid.

Electrical

37 kW, 50 hp	50 Hz	60 Hz	
Voltage	400 V	208 V to 230 V	460 V
Full-load current	73.8 A	138.2 A to 125.8 A	62.9 A
Primary circuit breaker rating	80.0 A	150.0 A	80.0 A

The pump uses 3-phase alternating current (AC) electricity. Some parts, such as valve solenoids and sensors, use 24-volt direct current (VDC) electricity from a power supply in the electrical enclosure.

Water

	Minimum	Maximum
CUTTING WATER IN		
Flow	7.6 L/minute (2 gallons/minute)	—
Pressure	2.8 bar (280 kPa / 40 psi)	7.6 bar (760 kPa / 110 psi)
CUTTING WATER OUT		
Flow	—	3.8 L/minute (1 gallon/minute)
Pressure	345 bar (34,500 kPa / 5,000 psi)	4,140 bar (414,000 kPa / 60,000 psi)
Cut pressure factory setpoint	—	4,140 bar (414,000 kPa / 60,000 psi)
Pierce pressure factory setpoint	1,380 bar (138,000 kPa / 20,000 psi)	—
COOLING IN and COOLING OUT		
Flow	11.4 L/minute (3 gallons/minute)	—
Pressure	2.8 bar (280 kPa / 40 psi)	7.6 bar (760 kPa / 110 psi)

HyPrecision P-60S

Dimensions and weights

Length	196 cm (77 in.)	Shipping weight	1,550 kg (3,400 lb)
Width	97 cm (38 in.)	Operating weight	1,450 kg (3,200 lb)
Height	155 cm (61 in.)		

The shipping weight is for the pump, the pallet, and the packaging. Exact weights are measured at shipment. Operating weight is for an unpackaged pump with hydraulic fluid.

Electrical

45 kW, 60 hp	50 Hz	60 Hz
Voltage	400 V	460 V
Full-load current	90.7 A	74.4 A
Primary circuit breaker rating	100.0 A	100.0 A

The pump uses 3-phase alternating current (AC) electricity. Some parts, such as valve solenoids and sensors, use 24-volt direct current (VDC) electricity from a power supply in the electrical enclosure.

Water

	Minimum	Maximum
CUTTING WATER IN		
Flow	9.5 L/minute (2.5 gallons/minute)	—
Pressure	2.8 bar (280 kPa / 40 psi)	7.6 bar (760 kPa / 110 psi)
CUTTING WATER OUT		
Flow	—	4.9 L/minute (1.3 gallons/minute)
Pressure	345 bar (34,500 kPa / 5,000 psi)	4,140 bar (414,000 kPa / 60,000 psi)
Cut pressure factory setpoint	—	4,140 bar (414,000 kPa / 60,000 psi)
Pierce pressure factory setpoint	1,380 bar (138,000 kPa / 20,000 psi)	—
COOLING IN and COOLING OUT		
Flow	11.4 L/minute (3 gallons/minute)	—
Pressure	2.8 bar (280 kPa / 40 psi)	7.6 bar (760 kPa / 110 psi)

HyPrecision P-75S

Dimensions and weights

Length	196 cm (77 in.)	Shipping weight	1,600 kg (3,500 lb)
Width	97 cm (38 in.)	Operating weight	1,500 kg (3,300 lb)
Height	155 cm (61 in.)		

The shipping weight is for the pump, the pallet, and the packaging. Exact weights are measured at shipment. Operating weight is for an unpackaged pump with hydraulic fluid.

Electrical

56 kW, 75 hp	50 Hz	60 Hz
Voltage	400 V	460 V
Full-load current	110.3	89.6 A
Primary circuit breaker rating	125.0 A	100.0 A

The pump uses 3-phase alternating current (AC) electricity. Some parts, such as valve solenoids and sensors, use 24-volt direct current (VDC) electricity from a power supply in the electrical enclosure.

Water

	Minimum	Maximum
CUTTING WATER IN		
Flow	11.4 L/minute (3 gallons/minute)	—
Pressure	2.8 bar (280 kPa / 40 psi)	7.6 bar (760 kPa / 110 psi)
CUTTING WATER OUT		
Flow	—	5.7 L/minute (1.5 gallons/minute)
Pressure	345 bar (34,500 kPa / 5,000 psi)	4,140 bar (414,000 kPa / 60,000 psi)
Cut pressure factory setpoint	—	4,140 bar (414,000 kPa / 60,000 psi)
Pierce pressure factory setpoint	1,380 bar (138,000 kPa / 20,000 psi)	—
COOLING IN and COOLING OUT		
Flow	11.4 L/minute (3 gallons/minute)	—
Pressure	2.8 bar (280 kPa / 40 psi)	7.6 bar (760 kPa / 110 psi)

Orifices

Metric (millimeters)



Number of orifices	HyPrecision P-15	HyPrecision P-30	HyPrecision P-50	HyPrecision P-50S	HyPrecision P-60S	HyPrecision P-75S
1	0.18	0.28	0.36	0.36	0.41	0.43
2	0.13	0.18	0.25	0.25	0.28	0.30
3	0.10	0.15	0.20	0.20	0.23	0.25
4	—	0.13	0.18	0.18	0.20	0.23
5	—	0.10	0.15	0.15	0.18	0.20
6	—	0.10	0.13	0.13	0.15	0.18

USA customary (inches)

Number of orifices	HyPrecision P-15	HyPrecision P-30	HyPrecision P-50	HyPrecision P-50S	HyPrecision P-60S	HyPrecision P-75S
1	.007	.011	.014	.014	.016	.017
2	.005	.007	.010	.010	.011	.012
3	.004	.006	.008	.008	.009	.010
4	—	.005	.007	.007	.008	.009
5	—	.004	.006	.006	.007	.008
6	—	.004	.005	.005	.006	.007

Torque values

If a fitting leaks after tightening it to the maximum torque value, disassemble the parts. Repair or replace parts that show deterioration, corrosion, or damage.

 WARNING	Do not use an adjustable wrench on high-pressure fittings.
	Use only enough torque to make a sufficient seal. Torque values can vary depending on thread condition. A sufficient seal can be made at values much lower than the maximum values shown in the table.

Fasteners

 WARNING	Do not use more torque than the values specified in these tables for load-carrying fasteners.
---	---

Because of high pressure in the intensifier, all fasteners used on hydraulic and high-pressure water parts are grade 8. Lock washers are necessary for fasteners that are used for cyclic loading.

Special fasteners

These torque values are for bolts that are coated in antiseize bolt lubricant (white lithium grease).

	Wrench size	N·m	lbf·ft
Indicator pin cap screw	5/32-inch hex	5	4
Proximity switch cap screw	3/16-inch hex	11	8
Hydraulic fluid tank access cover	15/16 inch	27	20
Intensifier cap screw	7/8 inch	373	275
High-pressure end cap nut	1-1/2 inch	373	275

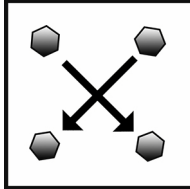
	<p>Tighten each end cap nut in 68 N·m (50 lbf·ft) increments. Use a repeating cross pattern.</p> <div style="text-align: center;">  </div>
---	--

8 – Pump specifications

SAE J518 flange bolts

i	Lubricate O-rings with hydraulic fluid or O-ring lubricant before installing them.
----------	--



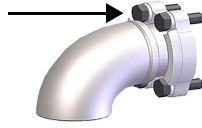

These torque values are for bolts that are coated in antiseize bolt lubricant (white lithium grease).

To make a good seal, the sealing face must be parallel to the mating surface and the bolt tension must be even. Align the flange face with the mating surface.



1/16-inch dash size	Bolt size	Code 61 grade 8		Code 62 grade 8	
		N-m	lbf-ft	N-m	lbf-ft
-08	5/16-28 inch	33	24	33	24
-12	3/8-16 inch	60	44	60	44
-16	3/8-16 inch	60	44	92	68
-20	7/16-14 inch	92	68	150	111
-24	1/2-13 inch	150	111	296	218

Fittings



 WARNING	Do not tighten a fitting too much. The fitting can fail.
 WARNING	Use 2 wrenches when loosening or tightening a high-pressure connection to prevent causing damage or premature failure.
	Do not use lubricants on low-pressure water fittings.
	Use a high-pressure antiseize lubricant such as Blue Goop or PURE Goop on high-pressure water fittings.

These charts apply to all hydraulic and high-pressure water fittings. All low-pressure water connections use push-to-connect fittings.

Some torque specifications are found on the technical drawings.

8 – Pump specifications

Special fittings

 WARNING	High-pressure water fittings are designed to make a tight seal. If a fitting is installed incorrectly, it can fail.
 WARNING	Do not tighten a fitting too much. The fitting can fail.

	Wrench size	Torque	
		N·m	lbf·ft
Output adapter	1 inch	115	85
High-pressure water fittings (gland nuts)			
1/4 inch	5/8 inch	34	25
3/8 inch	13/16 inch	68	50
9/16 inch	1-3/16 inch	150	110

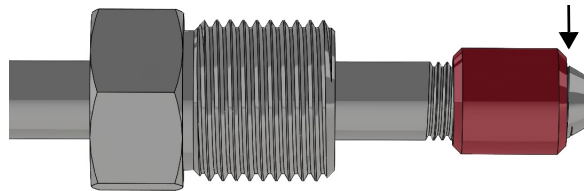

Incorrectly installed collar: The collar interferes with the sealing surface.

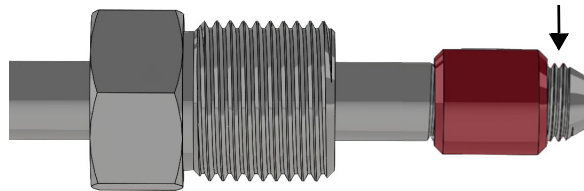

Correctly installed collar: The sealing surface is showing.

8 – Pump specifications

Hydraulic fittings

NPT

Hypertherm recommends thread sealant for all NPT fittings.

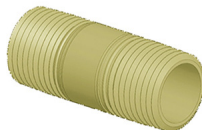

Size (inch)	Maximum torque value					
	Standard		with thread sealant (75% of standard maximum)		for a male tapered pipe thread with a female straight or parallel pipe thread (50% of standard maximum)	
	N·m	lbf·ft	N·m	lbf·ft	N·m	lbf·ft
1/4	34	25	26	19	18	13
3/8	47	35	35	26	24	18
1/2	61	45	46	34	31	23
3/4	75	55	56	41	38	28
1	88	65	66	49	45	33
1-1/4	108	80	81	60	54	40
1-1/2	129	95	96	71	65	48

This table shows maximum values. The torque necessary to make a sufficient seal depends on the condition of the pipe threads and can be much lower than the maximum.

8 – Pump specifications



Steel JIC 37°

	Lubricate the threads of steel JIC fittings with hydraulic fluid.
---	---



1/16-inch dash size	Minimum		Maximum	
	N·m	lbf·ft	N·m	lbf·ft
-04	14	10	15	11
-06	23	17	26	19
-08	46	34	52	38
-10	68	50	76	56
-12	95	70	106	78
-16	127	94	141	104
-20	168	124	187	138
-24	212	156	235	173

SAE O-ring boss

	Do not use thread sealant on SAE hydraulic fittings.
	Lubricate O-rings with hydraulic fluid or O-ring lubricant before assembly.



1/16-inch dash size	Minimum		Maximum	
	N·m	lbf·ft	N·m	lbf·ft
-04	14	10	16	12
-06	24	18	27	20
-08	43	32	47	35
-10	62	46	68	50
-12	88	65	95	70
-16	125	92	136	100
-20	169	125	190	140
-24	203	150	224	165

Section 9













Installation

In this section



- Safety
- Buyer responsibilities
- Requirements
- Receive and unpack the equipment
- Install the pump
- Install the optional equipment
- Make the utility connections
- Do the first start
- Operator interface: Adjustment screens
- Remote operation
- Storage

i	Images in this manual are for reference purposes. It is possible that your product is not shown accurately.
	This section assumes that the user is familiar with the Safety, Operation, and Pump specifications sections of this manual.
	It is possible that not all of the information in this section applies to all pump models.



Safety

	<p>Refer to the instruction manual. Read and understand all of the safety guidelines in this manual.</p>
 DANGER	<p>A waterjet is a cutting tool. Keep away from high-pressure streams and leaks. Pressurized fluid can cause injuries.</p> <p>A high-pressure injection injury is a surgical emergency. Get medical treatment immediately for all high-pressure waterjet injuries.</p> <p>Delayed treatment can cause injuries or death. Abrasive waterjets eject a mixture of water and abrasive materials that can be injected into body tissues, leading to a dangerous infection.</p>
 DANGER	<p>DANGEROUS VOLTAGE/RISK OF SHOCK</p> <p>To reduce the risk of injuries or death, wear approved protection and obey safety recommendations when doing work with electricity.</p>
 DANGER	<p>Doing work on this equipment while it is energized is dangerous.</p> <p>Personnel who maintain and repair this equipment can be injured or killed if dangerous energy is not controlled. Injuries can include burns, cuts, fractures, or electrocution.</p> <p>Before opening the electrical enclosure or doing maintenance or repairs on this equipment, turn off the electrical power and release water pressure and hydraulic pressure from the system.</p> <p>Use standard lock out–tag out procedures. Isolate all sources of electrical, mechanical, hydraulic, pneumatic, chemical, thermal, or other energy with a lockable energy-isolating device that satisfies national and local requirements.</p> <p>All work that requires opening the electrical enclosure or removing covers or panels from this equipment must be done only by an approved technician.</p>
 DANGER	<p>A person who works on deenergized machinery can be injured or killed if the machinery is energized without permission.</p> <p>All personnel in an area where energy-control procedures are used must receive training for energy-control procedures.</p>
 DANGER	<p>Do not stand in line with high-pressure fittings when operating this equipment. If a high-pressure fitting fails, it can cause a stream of water or hydraulic fluid to eject from the system with force.</p>
 WARNING	<p>Keep a restricted-access area clear that larger than the maximum movement range of the cutting equipment's moving parts.</p>
 WARNING	<p>Personal protective equipment is recommended. If you do not use personal protective equipment, there is a risk of injury or death.</p>
 WARNING	<p>Permit only approved personnel to operate, maintain, and repair this machinery.</p>
 WARNING	<p>Do not leave waterjet cutting equipment unattended while it is operating.</p>
 WARNING	<p>Do not operate the pump without the shaft access cover and all other safety devices correctly installed.</p>
 WARNING	<p>Make sure that all connections, fasteners, locking devices, hoses, and fittings are tight before operation.</p>

9 – Installation

 WARNING	<p>Do not block or remove warnings, cautions, or instructions.</p>
 CAUTION	<p>Do not touch a hot surface. Water leaking from a high-pressure fitting or the bleed-down valve can be hot.</p>
  CAUTION	<p>High-pressure water can cause eye injuries. Wear approved eye protection when operating or doing work near this equipment.</p>
  CAUTION	<p>This waterjet equipment could make more noise than is permitted by national or local codes. When this intensifier is operating, the noise level is 75 dB(A) to 80 dB(A). Water flow rate, pipe layout, and the acoustical characteristics of the building have an effect on noise level. Long periods of exposure to noise can cause permanent hearing loss. Wear approved ear protection and control exposure time when operating or doing work near this equipment.</p>
  CAUTION	<p>High-pressure water can cause cuts, abrasions, and punctures. Precision parts can have sharp corners or edges. Wear approved hand protection when operating or doing work near this equipment and when touching parts.</p>
  CAUTION	<p>Some materials can cause airborne contamination or particles when cut. Wear approved respiratory protection when operating or doing work near this equipment.</p>
	<p>All installation, repairs, and maintenance of the electrical and plumbing systems must obey national and local codes. This work should be done only by an approved technician. It is the buyer's responsibility to investigate and obey all local codes.</p>
	<p>Obey all safety requirements and applicable safety laws and regulations.</p>
	<p>Use SAE tools for most procedures.</p>
	<p>Keep the work area clean and dry. Clean fluid spills immediately. Use catch basins under areas where water or hydraulic fluid can spill during maintenance or repair procedures.</p>

Buyer responsibilities



 WARNING	This pump can supply water pressure of up to 4,140 bar (414, 000 kPa / 60, 000 psi). Only use tubing that is rated for this pressure.
 WARNING	Use supports for plumbing to prevent damage to plumbing from bending stress and fatigue from vibration.

The buyer is responsible for these obligations:

- Cooperate with Hypertherm and the Hypertherm original equipment manufacturer (OEM) regarding the installation of the equipment.
- Obey all setup and first-time start up instructions in this manual.
- Research and obey all local codes, including requirements for waste water disposal.
- Install high-pressure tubing.
- Install water-treatment equipment before the pump is installed.
- Make sure that all utilities are available during installation. The site must have sufficient electrical power, air, water, and drain access.
- Make all connections to the pump.
- Fill the hydraulic fluid tank. Hypertherm does not always ship the pump with hydraulic fluid in the tank.
- Perform user qualification and training. Refer to **User qualification and training** on page SC-22 for information.

Requirements

Location

 WARNING	Some locations can be dangerous if the atmosphere contains gas, vapors, or dust in explosive quantities. Refer to requirements from the National Electric Code (NEC), the International Electrotechnical Commission (IEC), the Occupational Safety and Health Administration (OSHA), and other national and local codes for information about environmental criteria.
	Make sure that there is a minimum clearance of 91 cm (36 inches) on all sides of the equipment to permit air movement for cooling and space for maintenance and repairs.

Put the equipment on a flat surface, such as concrete, that can hold the weight of the equipment and is thick enough to resist vibration. The feet on the frame can be adjusted to level the pump with two 1-1/8-inch open-ended wrenches.

Make sure that there is sufficient space for auxiliary equipment such as a water softener, a reverse osmosis system, or a chiller.

Temperature

	Do not install this equipment in an area where the temperature is below freezing. Freezing can cause damage to low-pressure and high-pressure water parts.
---	--

For temperature specifications, refer to **Environmental conditions** on page 178.

Ambient temperature can have an effect on cooling. Supplementary cooling can be necessary for a pump that is installed in a small or high-temperature location.

Cooling

HyPrecision pump model	kW (minimum)	Refrigeration tons (minimum tons)	Heat removal requirement (minimum Btu/hour)
P-15	3	0.85	10,000
P-30	6	1.70	20,000
P-50 and P-50S	9	2.70	32,000
P-60S	11.5	3.30	40,000
P-75S	14	4.00	48,000

Chiller

	Do not use a glycol solution in a chiller at a concentration higher than 25%.
---	---

Using a chiller with a water-glycol solution can have an effect on the performance of the heat exchanger.

Hydraulic fluid

For hydraulic fluid specifications, refer to **Hydraulic fluid** on page 178.



Hypertherm does not always ship the pump with hydraulic fluid in the tank.

9 – Installation

Utilities

 WARNING	All installation, repairs, and maintenance of the electrical and plumbing systems must obey national and local codes. This work should be done only by an approved technician. It is the buyer's responsibility to investigate and obey all local codes.
---	---

Electrical power

 WARNING	A line disconnect switch for incoming electrical power must be installed near the power supply. This is a supply-voltage disconnecting device or an energy-isolating device.
 CAUTION	The primary feed circuit breaker or fuse must be the correct size to control inrush and steady-state current. Use a motor-start circuit breaker or an equivalent if time-delay high-inrush fuses are not permitted by national or local codes.

The motor size determines the full load amperes, the overload settings, and the wire sizes. Refer to your pump model in the **Pump specifications** section or to the system schematic drawing.

Supply water

	Do not use deionized water unless the system has stainless steel water fittings. Deionized water can cause the plumbing parts to fail.
---	--

For minimum and maximum flow rates, pressure, and temperature specifications, refer to the **Pump specifications** section, which begins on page 177.

Check local codes to determine if a backflow prevention valve is necessary to separate the pump from the facility's potable water.

Water quality

Before installing this equipment, do a water quality analysis. Water quality reports that show pH, silica, and hardness levels are frequently available for no charge from public utility water suppliers.

Softened water is necessary for most systems. Get advice from a specialist for recommendations for choosing a water treatment system. Reverse osmosis systems are available from Hypertherm.

Test the water quality



Parts, tools, and materials

1-13897 TDS meter	pH tester
Container for a water sample	Silica test kit
Clean, deionized water or filtered water	Water hardness (calcium carbonate) test kit



1. Take a sample from the WASTE WATER OUT hose. If you can not access the hose, take a sample of the supply water going into the pump. Make sure that the water is clear and odorless.
2. Test the pH. The optimal pH measurement is between 6.0 and 8.0.
3. Test the silica (SiO_2) content. The silica content must be lower than 0.0015% (15 parts per million [ppm]).
4. Test the water hardness. The result must be equal to or lower than 0.006% (60 ppm / 3.5 grains per gallon).
5. Test the total dissolved solids (TDS) concentration. Refer to **Test the low-pressure water TDS level** on page 95 for instructions. The optimal range is 0.005% to 0.015% (50 ppm to 150 ppm).

Compressed air

Air pressure that is too low can prevent the bleed-down valve from closing and can cause the intensifier to overstroke.

Air pressure that is too high can cause damage to the needle and the seat in the bleed-down valve. If the available air pressure is too high, install an air regulator (not included) to reduce the pressure.

Receive and unpack the equipment

 WARNING	<p>Lifting must be done by a trained operator.</p> <p>Obey all work site safety requirements, the safety instructions for the lifting equipment, and the safety information in this manual.</p>
	<p>For easy reference, write your pump information on the Pump information page at the front of this manual (page 11).</p>
	<p>Boxes and parts are frequently packed in the pump, or in crates, boxes, and packaging. Look for accessories and spare parts before discarding the packaging.</p>

1. Examine containers, crates, and pallets for damage.
2. Remove the equipment from the shipping crates and pallets.
3. Examine the equipment to make sure that it was not damaged during shipping. If the equipment is damaged, a claim must be filed with the carrier.
4. Make sure that the delivery and shipping documents match the equipment that was ordered and what was received. Report shortages or damages to the OEM or to Hypertherm Waterjet within 10 days of receipt of the equipment.
5. Make sure that these items are included with the pump.
 - Dirty water container
 - Tool kit (optional), refer to page 138
 - Spare parts kit (optional), refer to page 139
 - Cord grip connector, two -16 JIC female connectors, and 2 hydraulic hoses for the external heat exchanger (optional)
 - The hoses are approximately 9 m (30 feet) long.
 - The water hose and a cord grip connector for the external boost pump (optional)
 - These items are usually found in the electrical enclosure:
 - Key for the LOCAL/REMOTE key switch
 - Key for the electrical interlock (optional)
 - MicroSD card adapter
 - System schematic drawing

Install the pump



WARNING

Make sure that all connections, fasteners, locking devices, hoses, and fittings are tight.

These instructions are for a typical installation. It could be necessary to install the components in a different order.



Parts, tools, and materials

Two 1-1/8-inch open-ended wrenches

Level

When the unit is in position, use adjustable wrenches to level the unit. There are 2 nuts on each leveling foot on the corners of the frame. Use the lower nut to set the height. The upper nut tightens against the pump frame to keep the leveling foot from moving.

Install the external heat exchanger (optional)

An external heat exchanger is optional.



Parts, tools, and materials

1-12092 24 mm cord grip

24 mm or 15/16-inch open-ended wrench
(for the cord grip base)

1-1/16-inch open-ended wrench
(for the sealing locknut)

HyPrecision P-15/P-30 pumps have a 3/4-inch hose with a 1-1/4-inch hex fastener on the fitting.

HyPrecision P-50/P-50S/P-60S/P-75S pumps have 1-inch hydraulic hoses with a 1-5/8-inch hex fastener.

1. Use the attached mounting bars to secure the heat exchanger to the ground or on an elevated platform.
2. Locate the wiring access hole in the bottom of the electrical enclosure.



HyPrecision P-15/P-30/P-50 pump



HyPrecision P-50S/P-60S/P-75S pump

3. Remove the wing nut holding the hole plug.



Keep the plug and the wing nut to use if the pump is stored or shipped.

9 – Installation

- Put the cord grip connector on the cord.



- Put the cord and the threaded end of the cord grip connector through the hole.
- Put the lock nut on the cord grip connector.



- Connect the motor wires (L1, L2, and L3) to the motor starter. Connect the ground wire to the grounding lug (PE).
- Tighten the gland nut on the cord.



- The heat exchanger includes 2 hydraulic hoses. Connect the hoses to the utility panel. Refer to **Make the connections to the utility panel** on page 205.

Install the external boost pump (optional)

An external boost pump is optional for HyPrecision P-15/P-30/P-50 pumps.

A boost pump increases the supply water pressure to 7.6 bar (760 kPa / 110 psi). A sustained pressure of lower than 2.8 bar (280 kPa / 40 psi) or meeting the maximum set pressure of 8 bar (800 kPa / 115 psi) causes the pump to turn off.

The boost pump assembly includes a pump, a 1-way check valve, and a bypass relief valve. The relief valve prevents overpressure in the low-pressure water system.



Parts, tools, and materials

Adjustable wrench

13/16-inch open-ended wrench

7/8-inch wrench

The 15-foot water hose has a 1/2-inch fitting.

1. Locate the wiring access hole in the bottom of the electrical enclosure.



HyPrecision P-15/P-30/P-50 pump



HyPrecision P-50S/P-60S/P-75S pump

2. Remove the wing nut holding the hole plug.



Keep the plug and wing nut to use if the pump is stored or shipped.

3. Put the cord grip connector on the cord.



4. Put the cord and the threaded end of the cord grip connector through the hole.

9 – Installation

5. Put the lock nut on the cord grip connector.



6. Connect the motor wires (L1, L2, and L3) to the motor starter. Connect the ground wire to the grounding lug (PE).
7. Tighten the gland nut on the cord.



8. Connect the supply water to the fitting on the boost pump that is marked **INLET**.
9. The boost pump includes 1 water hose. Connect 1 end of the hose to the fitting marked **OUTLET** on the boost pump.
10. Connect the other end of the hose to the CUTTING WATER IN fitting on the pump's utility panel. Refer to **Make the connections to the utility panel** on page 205.

Install the external plumbing package (optional)

The plumbing package is designed to make installing high-pressure tubing from the pump to the cutting table easier. A whip bracket reduces stress on the tubing and the necessity for 90° bends.



Parts, tools, and materials

1-15578 Pump-mounted plumbing kit

Set of standard wrenches

1. Find the mounting holes for the plumbing kit on the rear of the pump above the utility panel.



HyPrecision P-15/P-30/P-50 pump

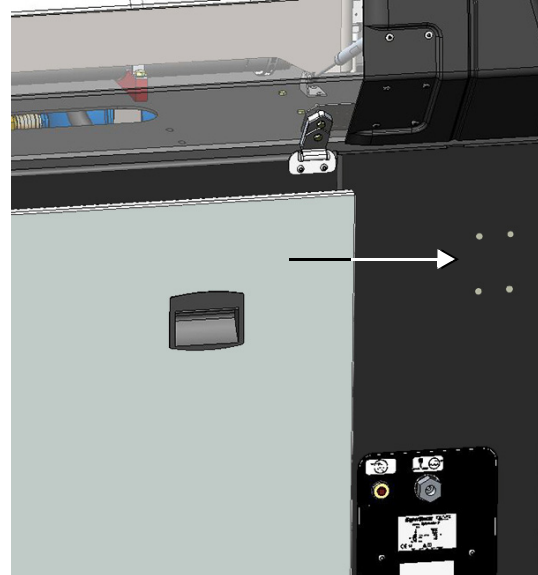





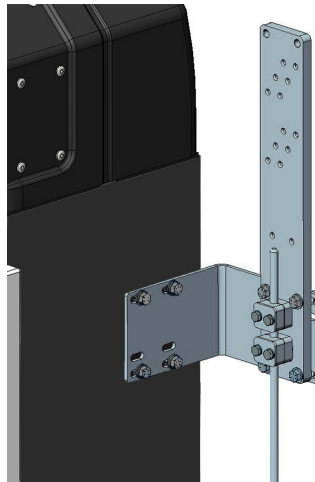

HyPrecision P-50S/P-60S/P-75S pump

2. Use the mounting holes to install the angle plate on the pump frame.
3. Use the included hardware to mount the high-pressure tubing whip bracket on the angle plate.



4. After the high-pressure tubing is connected to the utility panel, install the high-pressure tubing clamps on the whip bracket.

Make the connections to the utility panel

 CAUTION	Compressed air is an energy source that can eject with force. Be careful when connecting to and disconnecting from this energy source.
 WARNING	Water-cooled system Do not connect the WASTE WATER OUT hose and the COOLING OUT hose together. Connecting these hoses can cause cooling water to back up into the system, which can cause damage to the bleed-down valve and intensifier parts.
 CAUTION	Air-cooled pump If the COOLING IN hose and the COOLING OUT hose are not connected to the external heat exchanger before starting the motor, the hydraulic hoses can be damaged.
 WARNING	Do not tighten a fitting too much. The fitting can fail.
 CAUTION	To prevent dirty water from entering the bleed-down valve, install the WASTE WATER OUT hose so that it is below the fitting on the pump.
 WARNING	Do not use an adjustable wrench on high-pressure fittings.

The diagram on page 36 shows the flow of water through the pump system.

9 – Installation

These fittings are found on the utility panel on the rear of the pump. Refer to **Utility panel** on page 43 for detailed descriptions.

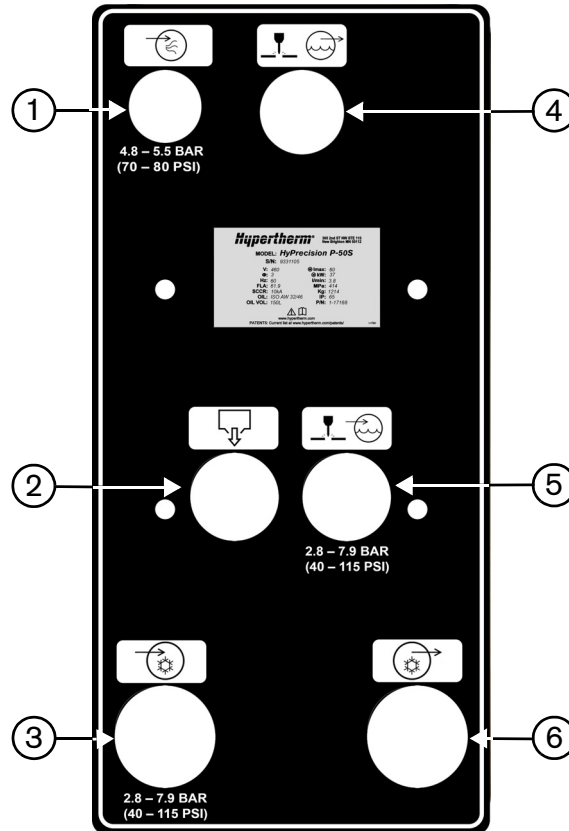

- | | |
|---------------------|---------------------|
| 1 COMPRESSED AIR IN | 4 CUTTING WATER OUT |
| 2 WASTE WATER OUT | 5 CUTTING WATER IN |
| 3 COOLING IN | 6 COOLING OUT |



Parts, tools, and materials

- | | |
|------------------------------|---|
| 13/16-inch open-ended wrench | Two 1/2-inch NPT male connectors |
| 1-1/2-inch open-ended wrench | 3/8-inch high-pressure female connector |
| 5/8-inch open-ended wrench | Two 1-inch NPT male connectors
(for a water-cooled system) |
| 1/4-inch NPT male connector | |

1. Remove the fitting caps and the plugs from the utility panel.



Keep the caps and plugs to use if the pump is stored or shipped.

2. Connect the compressed air hose and the water lines to the utility panel.

9 – Installation



Refer to **Fittings** on page 188 for torque values.

<p>COMPRESSED AIR IN 1/4-inch NPT female</p>	<p>Compressed air operates the bleed-down valve.</p> <ol style="list-style-type: none"> 1. Connect a compressed air source to this fitting. 2. Set the air pressure between 4.8 bar and 5.5 bar (70 psi and 80 psi).
<p>WASTE WATER OUT 1/2-inch NPT female</p>	<p>This hose carries water from the bleed-down valve and the low-pressure system to a drain.</p> <ul style="list-style-type: none"> ▪ Connect the end of this hose to the drain. ▪ Connect the other end to the utility panel.
<p>COOLING IN Water-cooled system 1-inch NPT female Air-cooled system -16 JIC male</p>	<p>This line carries low-pressure supply water from the local utility or a chiller to the pump's cooling loop.</p> <ul style="list-style-type: none"> ▪ Connect the end of this line to the supply water or to the chiller. ▪ Connect the other end to the utility panel. <p>This hose carries hydraulic fluid from the external heat exchanger to the hydraulic fluid tank.</p> <ul style="list-style-type: none"> ▪ Connect the end of this hose to the fitting marked OUTLET on the external heat exchanger. ▪ Connect the other end to the utility panel.
<p>CUTTING WATER OUT 3/8-inch high-pressure female</p>	<p>This tubing carries high-pressure water from the pump to the cutting table.</p> <ul style="list-style-type: none"> ▪ Connect the end of a high-pressure tubing to the cutting head. ▪ Connect the other end to the utility panel.
<p>CUTTING WATER IN 1/2-inch NPT female</p>	<p>This line carries low-pressure water from a water softener, a reverse osmosis system, a well, or a public utility to the pump.</p> <ul style="list-style-type: none"> ▪ Connect the end of this line to the supply water. ▪ Connect the other end to the utility panel.
<p>COOLING OUT Water-cooled system 1-inch NPT female Air-cooled system -16 JIC male</p>	<p>This line carries low-pressure water from the heat exchanger to the chiller or to the drain.</p> <ul style="list-style-type: none"> ▪ Connect the end of this line to the to the chiller or to the drain. ▪ Connect the other end to the utility panel. <p>This hose carries hydraulic fluid from the hydraulic fluid tank to an external heat exchanger.</p> <ul style="list-style-type: none"> ▪ Connect the end of the hose to the fitting marked INLET on the external heat exchanger. ▪ Connect the other end to the utility panel.

Add hydraulic fluid

Some pumps are shipped without hydraulic fluid. Make sure that hydraulic fluid is available during installation and for the first start. Refer to **Add hydraulic fluid** on page 82 for instructions.

Connect the electrical power

 CAUTION	HyPrecision pumps can leak up to 160 mA. To reduce the effects of a high leakage current, connect the pump to a dedicated supply transformer that has separate windings.
	Use electrical parts that are certified by national or local electrical codes.
	Hydraulic, water, and electrical connections can become loose during shipping and normal operation. We recommend examining all connections at installation and during regular maintenance.

The motor size determines the full load amperes, the overload settings, and the wire sizes. Refer to your pump model in the **Pump specifications** section or to the system schematic drawing.



1. Connect electrical power to the primary circuit breaker. The breaker is labeled on the technical drawing and in the electrical enclosure as CB-1.
2. Attach a ground leg to the grounding lug in the electrical enclosure.

Use this table to find the minimum cross-sectional area of the external copper ground leg.

If the cross-sectional area (S mm ²) of the copper phase conductors supplying the equipment is	The minimum cross-sectional area (S_p mm ²) is
equal to or higher than 16	equal to S
higher than 16 and lower than or equal to 35	16
higher than 35	$S/2$

Do the first start

Use this procedure at installation, when putting the equipment into operation after storage or shipping, and after maintenance or repairs are done on the intensifier, the high-pressure water system, or the low-pressure water system.

 <p>CAUTION</p>	<p>AIR-COOLED SYSTEM</p> <p>If the COOLING IN hose and the COOLING OUT hose are not connected to the external heat exchanger before starting the motor, the hydraulic hoses can be damaged.</p>
	<p>If a water line, a fitting, or a valve could be frozen, do not operate the pump. Thaw the equipment until water moves easily through the water circuit.</p>
	<p>Do not do the first start with a diamond orifice installed. There is a possibility that the procedure can cause damage to the orifice can during the first start.</p> <p>Hypertherm recommends using a ruby orifice during the first 40 hours of operation.</p>

Do a preoperation inspection

- Look for leaks, deterioration, damage, or other conditions that can interfere with operation.
- Look at the sight gauge on the hydraulic fluid tank. Add hydraulic fluid, if necessary.
- Close all doors and replace all panels and covers, including access covers.
- Make sure that all warning decals are visible and legible.



Turn on the utilities

	<p>Identify the source of a leak and correct the problem. Refer to Leaks on page 163.</p> <p>A leak can cause damage to the water fittings.</p>
---	---

1. Turn ON the electrical breaker.
2. Turn ON the water to the pump.
3. Monitor for leaks.
4. Turn ON the compressed air supply.
5. Turn ON the electrical main.
6. Turn the primary breaker disconnect lever on the electrical enclosure door to ON.

The operator interface screen is on when the pump is energized.

Make sure that the primary motor turns in the correct direction

 WARNING	<p>It is necessary to have access to a turning shaft for this procedure. Do not put an object or a body part near the shaft while the access cover is off.</p>
 CAUTION	<p>AIR-COOLED PUMP</p> <p>To prevent damage to the pump, connect the hydraulic hoses between the pump and the external heat exchanger before doing a check of the motor direction.</p>
 CAUTION	<p>Make sure that the primary motor turns in the correct direction before starting the pump.</p> <p>If the motor turns in the opposite direction, the impeller could turn and loosen. This can cause damage to the hydraulic pump.</p>

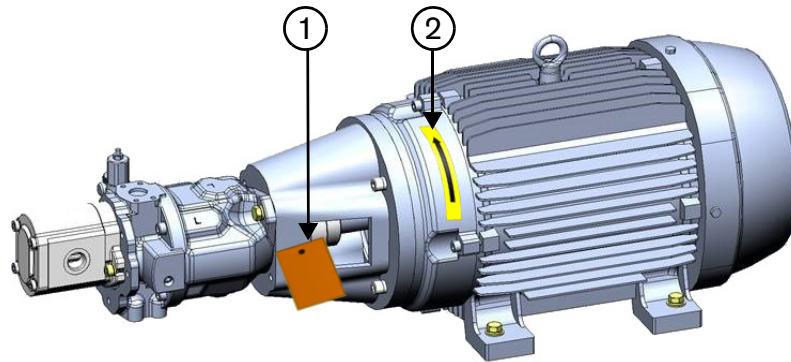

1 Shaft access cover

2 Rotation arrow

1. Remove the shaft access cover.
2. Make sure that the LOCAL/REMOTE key switch on the operation panel is set to LOCAL.

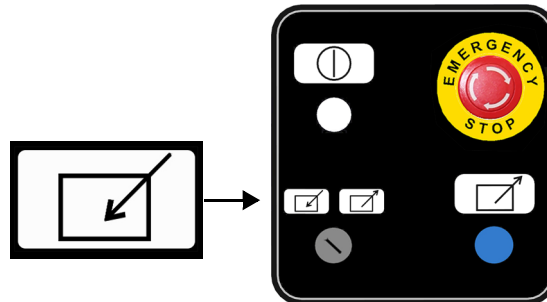

Refer to **Operator interface: Operation screens** on page 58 for information.

3. Push the CONTROLS ON button to turn ON the control circuit in the pump.

 The pump can not be turned on until the control circuit is on.

9 – Installation

- Turn ON the pump in cooling mode momentarily. Then touch the STOP symbol. The intent is to make the motor shaft turn so that you can see the direction it moves without starting the pump.

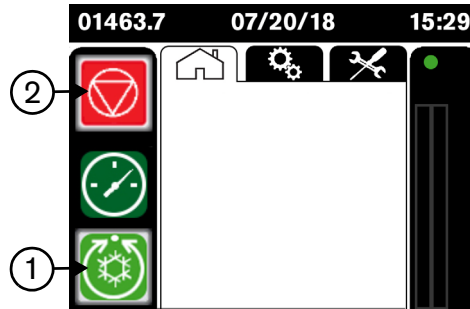

- COOLING ON
 - STOP
- Make sure that the primary motor turns in the direction shown by the rotation arrow.
If the pump motor turns in the wrong direction:
 - Disconnect the electrical power to the pump.
 - In the electrical enclosure, interchange 2 cables on the top of the primary circuit breaker.



- Make sure that the primary motor turns in the direction shown by the rotation arrow.
- Install the shaft access cover.

Make sure that the heat exchanger fan motor turns in the correct direction

1. Operate the pump until the fan turns on.
2. Make sure that the fan motor turns in the direction shown by the rotation arrow.

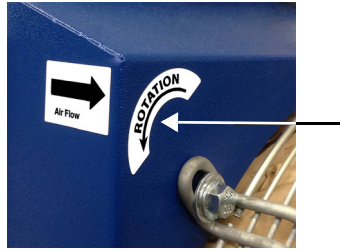

If the fan motor turns in the wrong direction:

- a. Disconnect the electrical power to the pump.
- b. In the electrical enclosure, interchange 2 wires on the bottom of the motor starter.



- c. Make sure that the fan motor turns in the direction shown by the rotation arrow.

Turn on the pump

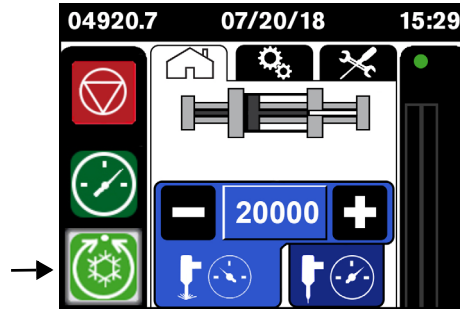

Identify the source of a leak and correct the problem. Refer to Leaks on page 163.
A leak can cause damage to the water fittings.

1. Turn ON the pump in cooling mode.
2. Let the pump operate for 2 to 3 minutes.
3. Monitor for leaks.

Adjust the external boost pump pressure



Do not set the boost pump pressure higher than 7.6 bar (760 kPa / 110 psi).
The supply water components are rated for a maximum of 8.6 bar (860 kPa / 125 psi).
High pressure can cause damage to the components.



If the supply water is from a reverse osmosis system, contact a Hypertherm Technical Service Associate for information and support.

HyPrecision P-50S/P-60S/P-75S pump

1. Turn ON the pump in cooling mode.
2. Remove the rear cover of the pump.
3. Locate the water manifold in the pump behind the utility panel.
4. Pull out the boost pump pressure regulator knob on the water manifold. Turn it clockwise to increase the pressure or counterclockwise to decrease pressure.
5. Make sure that the pressure on the prefilter water-pressure gauge is between 6.9 bar and 7.6 bar (690 kPa and 760 kPa / 100 psi and 110 psi).

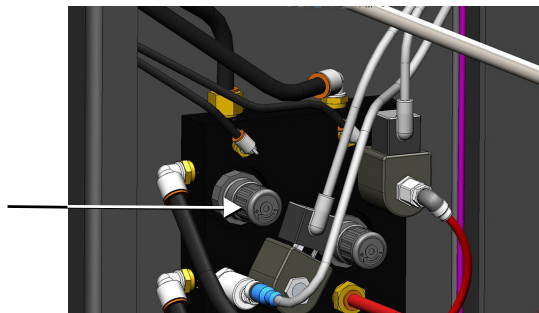

9 – Installation

HyPrecision P-15/P-30/P-50 pump (optional)



CAUTION

Do not set the boost pump pressure higher than 7.6 bar (760 kPa / 110 psi).
The supply water components are rated for a maximum of 8.6 bar (860 kPa / 125 psi).
High pressure can cause damage to the components.

The external boost pump includes a pump in an enclosure. A preboost gauge and a postboost gauge are on the enclosure.

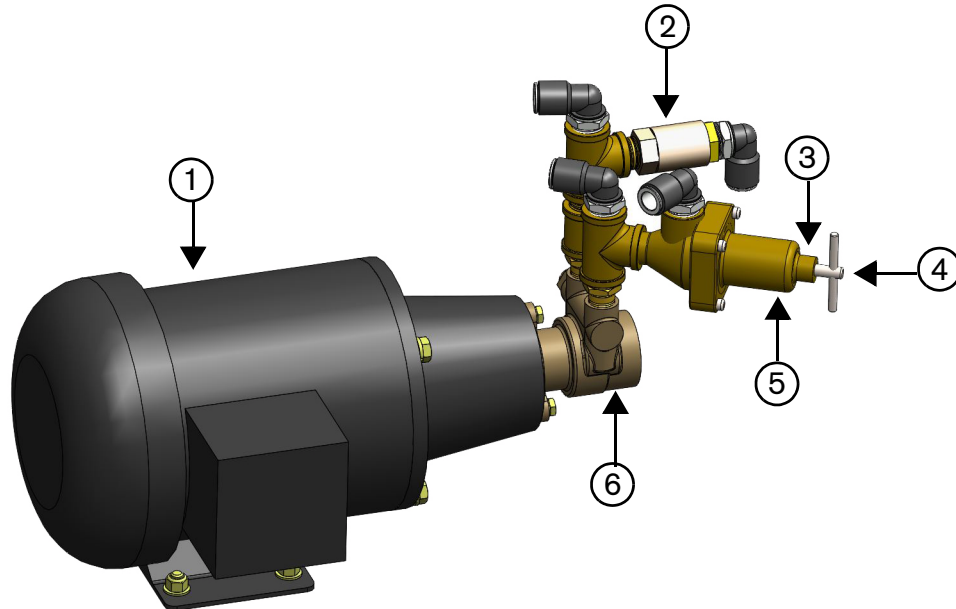

- | | |
|---------------|------------------------------|
| 1 Motor | 4 T-handled adjustment screw |
| 2 Check valve | 5 Bypass relief valve |
| 3 Jam nut | 6 Pump |



Parts, tools, and materials

9/16-inch open-ended wrench

Do this task when the pump is not running.

Make sure that the value on the prefilter water-pressure gauge is between 2.8 bar and 7.6 bar (280 kPa and 760 kPa / 40 psi and 110 psi).

If the pressure is not in this range:



1. Loosen the jam nut on the regulator.
2. Turn the T-handled adjustment screw clockwise to increase the pressure or counterclockwise to decrease pressure.
3. Tighten the jam nut.

Measure the air pressure in the water accumulator tank

Refer to **Measure the air pressure in the water accumulator tank** on page 92 for instructions.

Flush the pump and the high-pressure tubing

It is common for small pieces of metal and debris to be present in newly installed high-pressure tubing. Flush the system to prevent damage to orifices, on/off valve parts, and other parts of the high-pressure system.

	This procedure can cause damage to the on/off valve seals parts and orifices. Keep spare kits and orifices available.
	Debris can cause damage to the on/off valve needle and the seat.
	If this pump was purchased through an OEM, the OEM could recommend a different procedure to flush out the high-pressure tubing.

 This procedure identifies 1 method to flush out the high-pressure tubing. If this pump was purchased through an OEM, the OEM might recommend a different procedure.

 This procedure can cause damage to the on/off valve sealing parts and orifices. Keep spare kits and orifices available.

1. Remove the cutting head and the orifice.
2. Make sure that the on/off valve is closed.
3. Turn ON the pump.
4. Set the pressure to 1,380 bar (20,000 psi).
5. Start the pump.
6. Make a program that turns the valve on and off in 1-second increments. Operate the program in a loop for 15 minutes.

If a program is not available, turn the cutting head on and off in 1-second intervals for 15 minutes. This loosens debris in the high-pressure tubing.

7. Turn OFF the pump.
8. Install a ruby orifice in the cutting head. For orifice sizes, refer to the **Orifices** section, which begins on page 186.
9. Turn ON the pump.
10. Touch the RUN symbol.
11. Increase the pressure to 2,760 bar (40,000 psi). Operate the program in a loop for 15 minutes.
12. Increase the pressure to 4,140 bar (60,000 psi). Operate the program in a loop for 15 minutes.

If the on/off valve leaks, examine the needle, the seat, the seals, and the orifices for damage. Replace these parts, if necessary.

Operator interface: Adjustment screens

The adjustment screens on the operator interface let the user change the system configuration.

i	Not all screens are used when installing the pump.
i	Touch the current screen symbol to go back 1 screen.

There are 3 ways to interact with the adjustment screens.

1. Touch a field with a border around it.

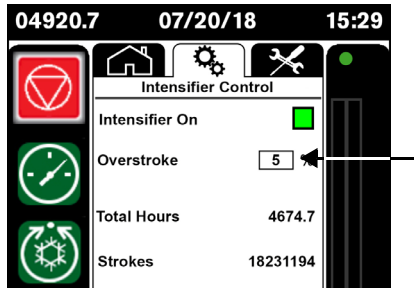

A numeric keypad opens. Touch **Enter** to save an entry. Touch **Esc** to go back 1 screen without saving the entry.

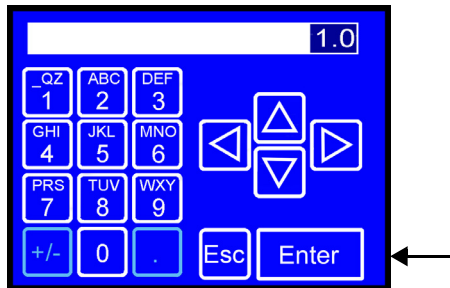

i	A field with no border means that the item is informational.
----------	--

2. Touch a square to turn a feature on (green) or off (gray).

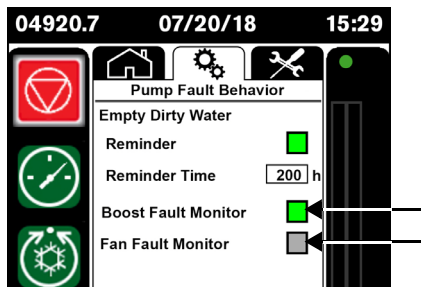

9 – Installation

3. Touch a symbol with a border around it. This usually opens another screen.

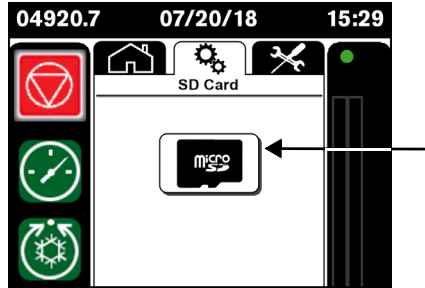

Primary adjustments screen

On the operator interface, touch the adjustments symbol to open the primary adjustments screen.

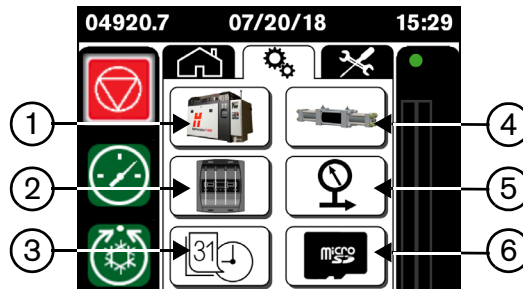

- | | |
|-------------------------------------|-----------------------|
| 1 Pump Adjustments | 4 Intensifier Control |
| 2 Seal Maintenance Indicator | 5 Pressures |
| 3 Enter or change the time and date | 6 SD Card |

Pump Adjustments

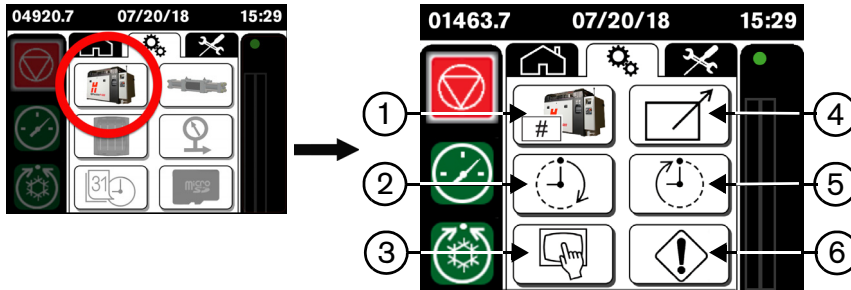

- | | |
|---------------------------------|--------------------------------|
| 1 Pump Information | 4 Remote Configuration |
| 2 Start-procedure Timers | 5 Stop-procedure Timers |
| 3 Pressure Adjustments | 6 Pump Fault Behavior |

Pump Information

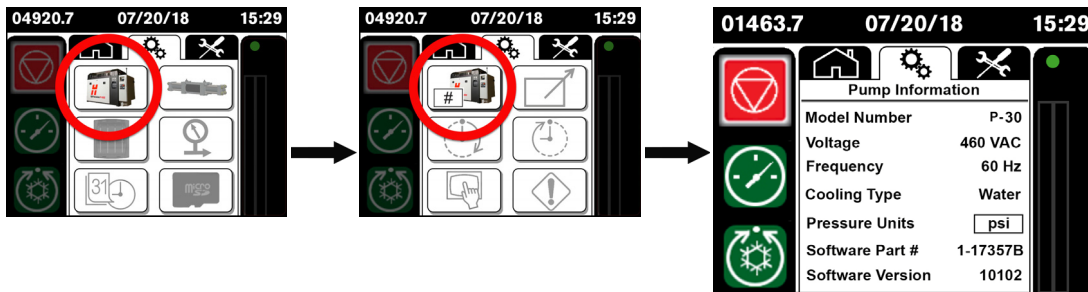

Model Number	This is the model number of the pump.
Voltage	This is the line voltage of the pump
Frequency	This is the line voltage frequency of the pump.
Cooling Type	Water: A standard pump has an internal water-cooling system. Air: An air-cooled pump has an external heat exchanger.
Pressure Units	Touch this field to open a keypad. Touch the up or down arrows to select the units (bar or psi) that show on the operator interface screens.
Software Part #	This is the Hypertherm part number for the software installed on the controller.
Software Version	This is the version of the software on the controller.

Start-procedure Timers

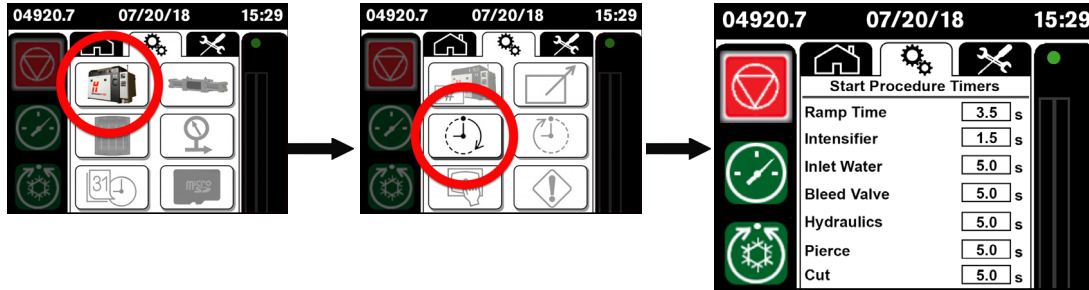

All time is in seconds.

Ramp Time	This is the time that the system takes to increase the high-pressure water from 0 to the high-pressure setpoint. Increase the value to slow the process. The default time is between 3 seconds and 8 seconds, based on the pump model. The value can not be lower than the default.
Intensifier	The system goes to the next stage of the start sequence when the time between intensifier strokes is this value. The default is 1.5 seconds.
Inlet Water	During the start sequence, after the system is at the minimum water manifold pressure target, the system stays in stage 1 for this time. The default is 5 seconds.
Bleed Valve	This is the time it takes for the intensifier to push air in the system out through the bleed-down valve. The default is 5 seconds.
Hydraulics	This is how long the system takes to get to the minimum hydraulic pressure after the bleed-down valve closes. The default is 5 seconds.
Pierce	This is how long the system takes to get to the pierce pressure target. The default is 5 seconds.
Cut	This is how long the system takes to get to the cut pressure target. The default is 5 seconds.

Pressure Adjustments

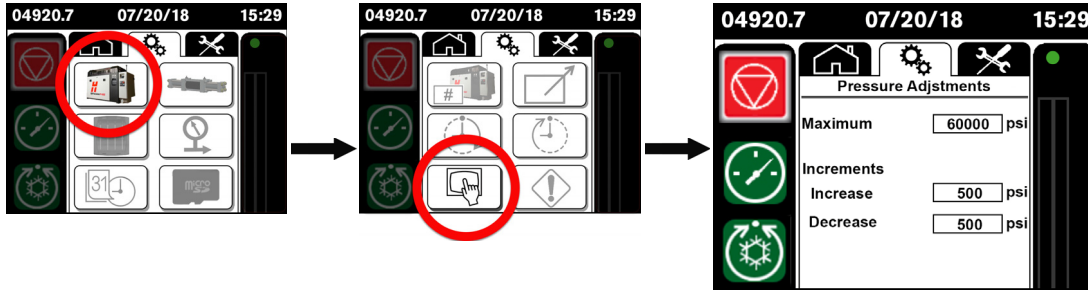

Maximum	This is the maximum pressure that the system can be adjusted to. The default is 4,140 bar (60,000 psi).
Increments	
Increase	This is how much that the target pressure increases each time the + symbol on the primary operation screen is touched. The default is 34 bar (500 psi).
Decrease	This is how much that the target pressure decreases each time the – symbol on the primary operation screen is touched. The default is 34 bar (500 psi).

Remote Configuration.

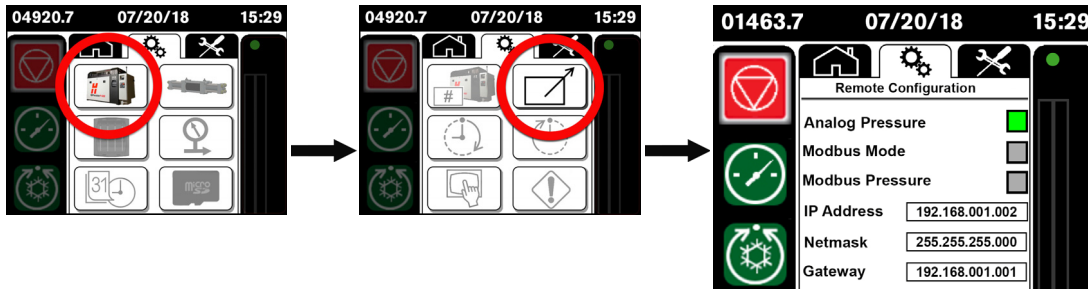

Analog Pressure	This turns the remote analog pressure input on or off.
Modbus Mode	Turn Modbus mode on or off. When this mode is on, the pump is controlled by Modbus TCP over Ethernet.
Modbus Pressure	This turns Modbus control of the pump pressure on or off.
IP Address	Enter a static IP address.
Netmask	Enter the netmask.
Gateway	Enter the gateway.

Stop-procedure Timers

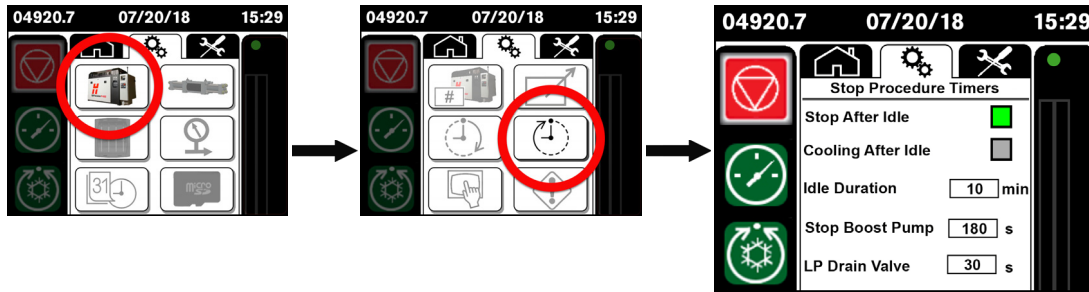

The pump is idle when the intensifier stops stroking.

Stop After Idle	When this feature is on, the pump turns off after the idle duration timer expires.
Cooling After Idle	When this feature is on, the pump goes into cooling mode after the idle duration timer expires.
Idle Duration	This timer determines how long the pump is idle before it turns off or goes into cooling mode. The default is 10 minutes.
Stop Boost Pump	This timer determines how long the pump is idle before the boost pump turns off. This applies to internal and external boost pumps. The default is 180 seconds.
LP Drain Valve	This timer determines how long after the pump turns off the low-pressure (LP) drain valve opens and releases the low-pressure water from the system. The default is 30 seconds.

Pump Fault Behavior

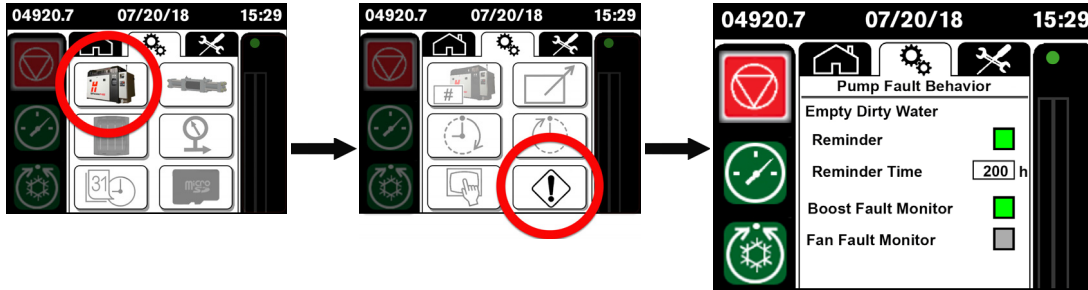

Empty Dirty Water	
<i>Reminder</i>	This turns the reminder feature on or off.
<i>Reminder Time</i>	This timer determines how long the pump operates before the reminder is displayed. The default is 200 hours.
Boost Fault Monitor	The system can monitor an internal or external boost pump for fault conditions. This turns monitoring on or off.
Fan Fault Monitor	The system can monitor an external heat exchanger for fault conditions. This turns monitoring on or off.

Seal Maintenance Indicator

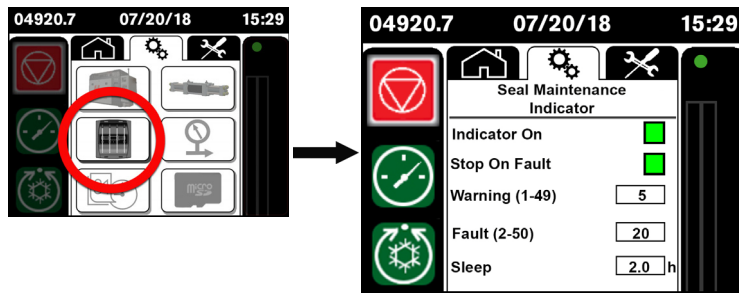

For information about faults and warnings, refer to **Troubleshooting** section, which begins on page 149.

Indicator On	This turns the Seal Maintenance Indicator (SMI) on or off.
Stop On Fault	This turns the Stop On Fault feature on or off. When this feature is on, the pump operates for 30 minutes after a fault is sensed and then turns off.
Warning	The Seal Maintenance Indicator senses leaks from the intensifier. This value determines the number of units that cause a warning. The default is 5 units.
Fault	This value determines the number of units that cause the system to turn off. The default is 20 units.
Sleep	If a fault occurs and the Stop On Fault feature is not on, this timer determines how long after a fault is acknowledged that the system pauses before showing the Alarms screen again. The default is 2.0 hours.



9 – Installation

Enter or change the time and date

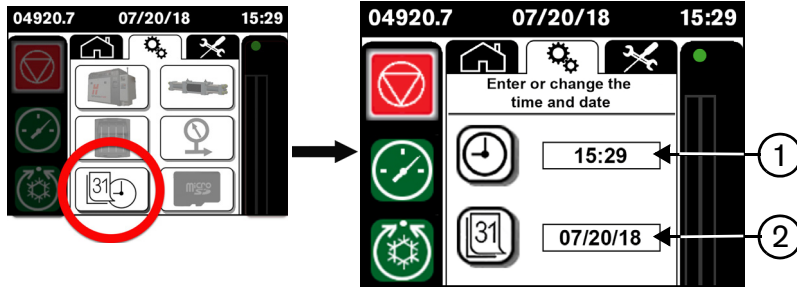
Change the date and time that is shown on the operator interface.



- 1 Time field
- 2 Date field

	Touch this symbol to change the time format. Select a 12-hour clock or a 24-hour clock.
	Touch this date symbol to change the date format. Select DD-MM-YY or MM/DD/YY.
Time field and date field	Touch this field to open a keypad. Touch the up or down arrows to change the value.

Intensifier Control

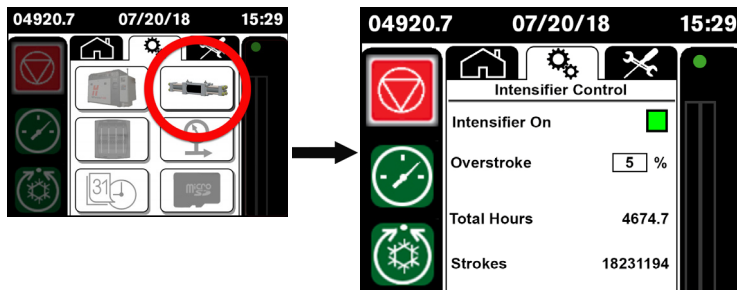

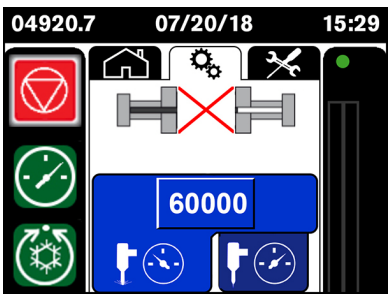
Intensifier On	<p>This turns the intensifier on or off.</p> <p>If intensifier control is off, the primary screen shows a red X on the intensifier symbol. Do this task when the pump is running in cooling mode or is turned off.</p> <div style="text-align: center;">  </div>
Overstroke	<p>Touch this field to open a keypad.</p> <p>Enter the maximum overstroke percentage permitted before a fault occurs. The default is 5%.</p>

9 – Installation

Total Hours	This shows the total hours that the intensifier has been in operation.
Strokes	This shows the total number of strokes on the intensifier. A stroke is counted each time a proximity switch is on.

9 – Installation

Pressures

This screen shows the supply water pressures and the hydraulic pressures.

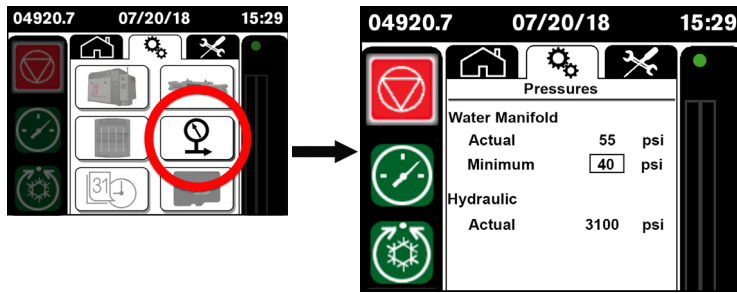

Water Manifold				
Actual	This shows the pressure coming out of the water manifold.			
Minimum	Touch this field to open a keypad. Enter the minimum pressure permitted before a fault occurs. The default pressure is based on the pump model.			
	HyPrecision P-15	2.6 bar (37 psi)	HyPrecision P-50S	2.0 bar (29 psi)
	HyPrecision P-30	2.4 bar (35 psi)	HyPrecision P-60S	1.7 bar (25 psi)
	HyPrecision P-50	2.1 bar (31 psi)	HyPrecision P-75S	1.5 bar (21 psi)
Hydraulic				
Actual	This shows the hydraulic pressure in the system.			

SD Card

The microSD card stores the current program, the alarm log files, and the maintenance log.

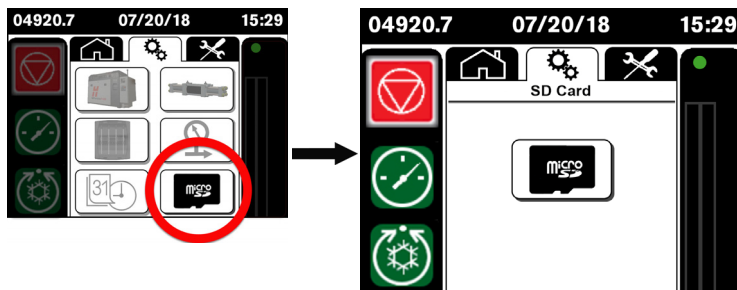

Touch the SD card symbol to see the contents of the card.

Removable Media			
ALARMS	<DIR>	09-22-18	4:54a
DRIP	<DIR>	10-02-18	1:49p
LDS	<DIR>	10-02-18	1:49p
LSS	<DIR>	10-02-18	1:49p
MAINT	<DIR>	09-26-18	6:15p
METRICS	<DIR>	10-02-18	1:49p
RDS	<DIR>	10-02-18	1:49p
RSS	<DIR>	10-02-18	1:49p
SYSTEM U	<DIR>	08-23-18	11:51p
ALARMS			
Free:	1926912	Total:	1928960
<div style="display: flex; justify-content: space-between;"> ← △ ▽ Del Del All For mat Save Pgm Esc </div>			

9 – Installation

If the microSD card is missing or damaged, this screen shows **SD Card Not Found**.

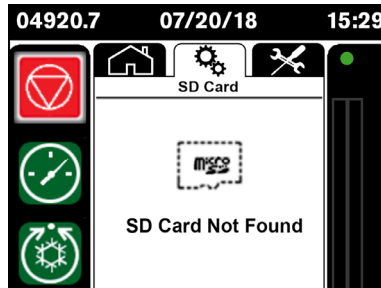

Remote operation

To connect the pump directly to an external control device, such as a CNC, refer to the CNC manual and contact a Hypertherm Technical Service Associate for information and support.

The electrical interlock is part of the emergency stop circuit. If the top cover is opened while the pump is on, the result is the same as pushing the **EMERGENCY STOP** button.

Storage

Refer to **Prepare for storage** on page 135 for information about storing this equipment.

Section 10

Technical drawings

In this section

- System schematic for HyPrecision Predictive P-15/P-30/P-50 pumps
- System schematic for HyPrecision Predictive P-15/P-30/P-50 pumps



If you are printing this manual from a PDF, Hypertherm recommends printing these pages on A3-, tabloid-, or ledger-size paper.

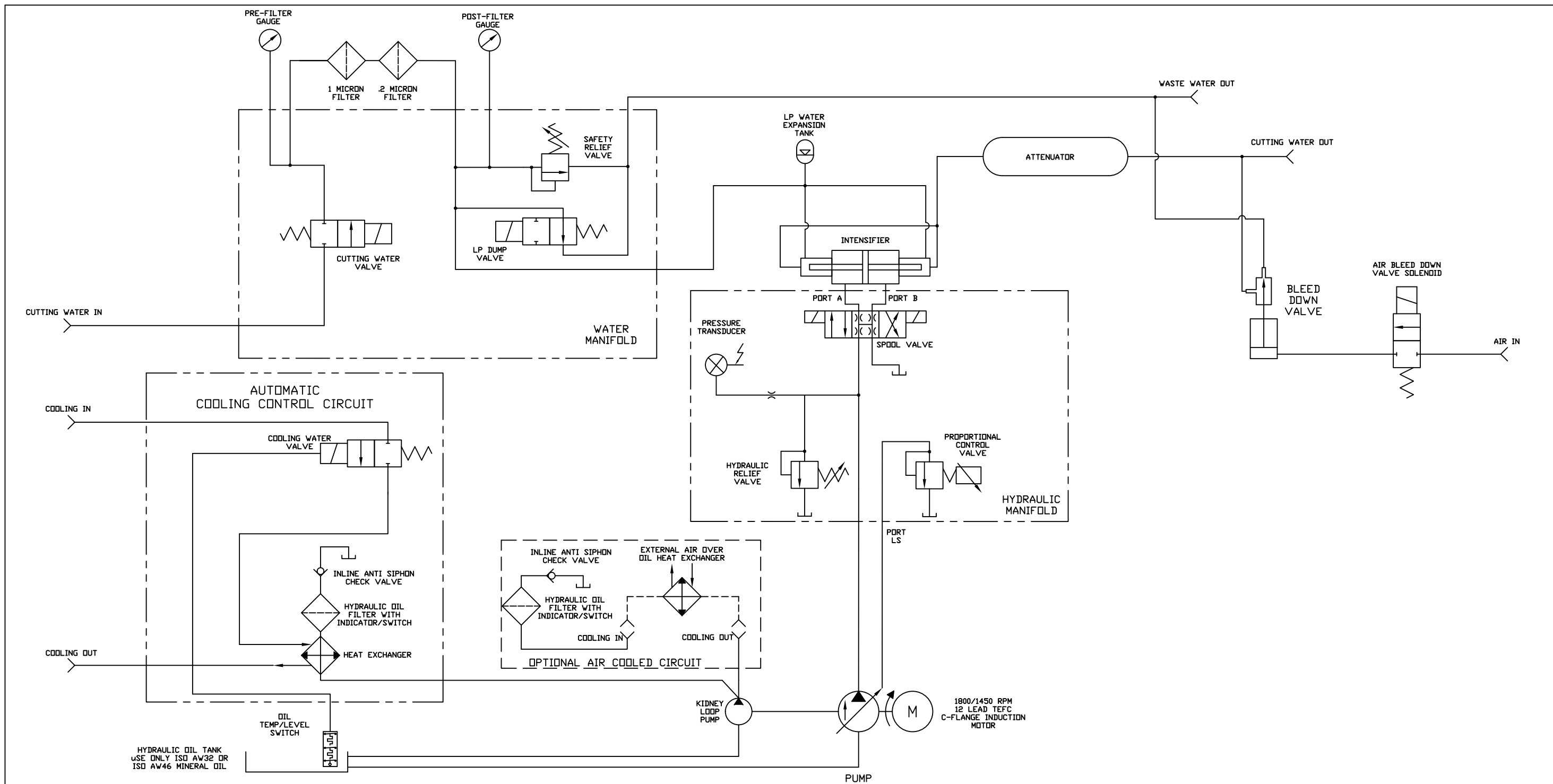

AUTOMATIC COOLING CONTROL CIRCUIT
 HYDRAULIC OIL PROBE
 TEMP SENSOR 1 OPENS AT 55°C 130°F
 TEMP SENSOR 2 OPENS AT 65°C 150°F
 TEMP SENSOR 3 CLOSES AT 45°C 112°F
 FLOAT SWITCH OPENS ON LOW OIL LEVEL

HIGHLY CONFIDENTIAL PROPRIETARY INFORMATION				309 5TH AVENUE NW NEW BRIGHTON, MN 55112 EMAIL: WATERJET@HYPERTHERM.COM WEB: WWW.HYPERTHERM.COM		PHONE: 651-294-8600 FAX: 651-294-8620		TITLE: HYPRECISION_15/30/50 JUNO_SYSTEM_SCHEMATIC		
THIS DRAWING AND ALL INFORMATION CONTAINED THEREON IS CONSIDERED PROPRIETARY AND MAY NOT BE USED FOR MANUFACTURING OR FABRICATION PURPOSES WITHOUT PERMISSION FROM HYPERTHERM, INC.	-TOLERANCES- UNLESS OTHERWISE SPECIFIED DIMENSIONS IN INCHES ANGULAR: MACH ± 1 BEND ± 1 ONE PLACE DECIMAL ± .05 TWO PLACE DECIMAL ± .015 THREE PLACE DECIMAL ± .005 BREAK AND DEBURR ALL EDGES .015 MAX		NAME	DATE	MATERIAL	SHEET 1 OF 1	SCALE: 1:1	FINISH	REV 1	
	DRAWN	RAC	04/09/18							
		CHECKED				HARDNESS	SIZE B	DWG. NO. 1-17408		
	ENG APPR.	JEF	04/09/18		WEIGHT					

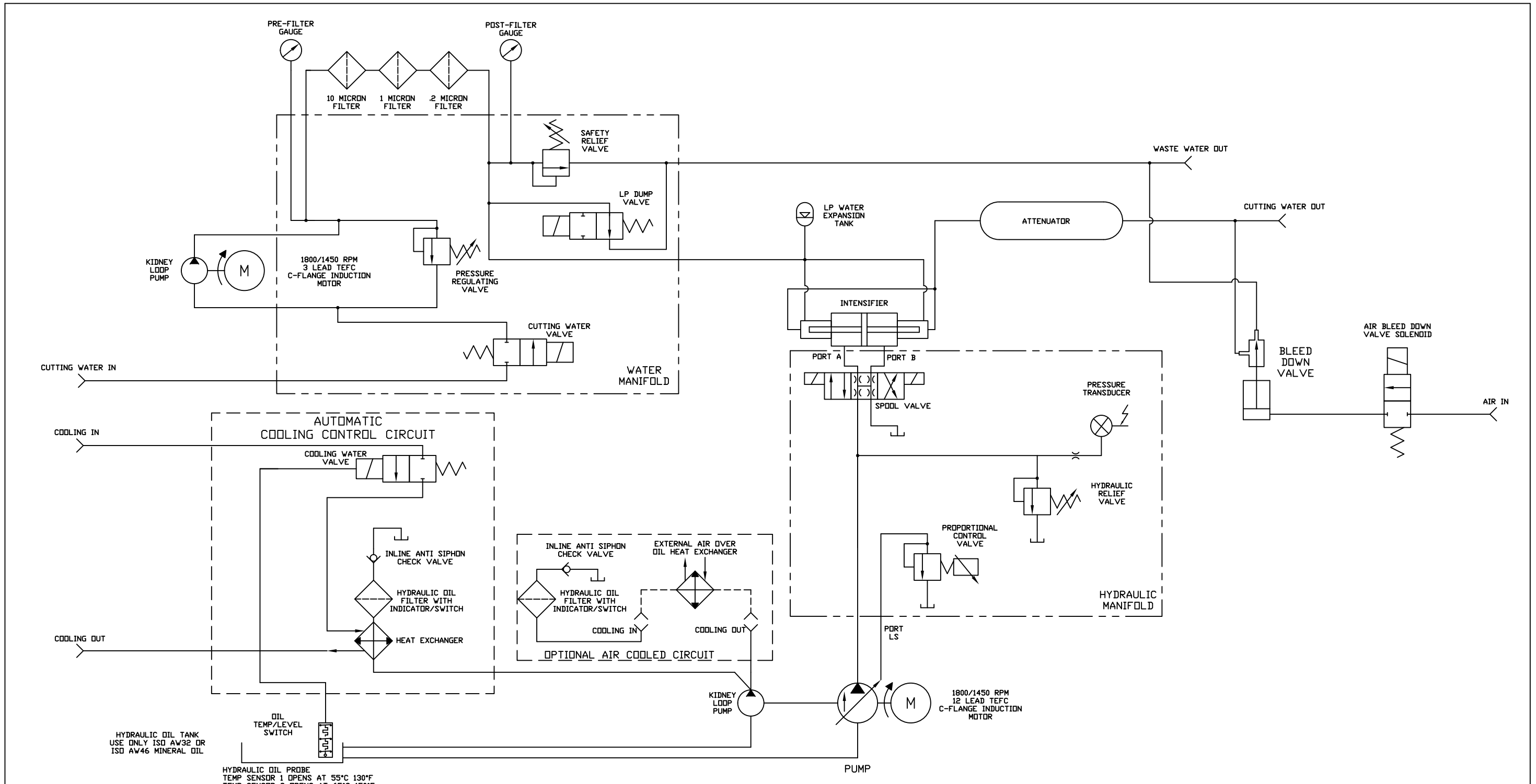

HYDRAULIC OIL TANK
USE ONLY ISO AW32 OR
ISO AW46 MINERAL OIL

HYDRAULIC OIL PROBE
TEMP SENSOR 1 OPENS AT 55°C 130°F
TEMP SENSOR 2 OPENS AT 65°C 150°F
TEMP SENSOR 3 CLOSES AT 45°C 112°F
FLDAT SWITCH OPENS ON LOW OIL LEVEL

HIGHLY CONFIDENTIAL PROPRIETARY INFORMATION		309 5TH AVENUE NW PHONE: 651-294-8600 NEW BRIGHTON, MN 55112 FAX: 651-294-8620 EMAIL: WATERJET@HYPERTHERM.COM WEB: WWW.HYPERTHERM.COM			TITLE: HYPrecision_50S/60S/75S JUNO_SYSTEM_SCHEMATIC															
THIS DRAWING AND ALL INFORMATION CONTAINED THEREON IS CONSIDERED PROPRIETARY AND MAY NOT BE USED FOR MANUFACTURING OR FABRICATION PURPOSES WITHOUT PERMISSION FROM HYPERTHERM, INC.		-TOLERANCES- UNLESS OTHERWISE SPECIFIED DIMENSIONS IN INCHES ANGULAR: MACH ± 1 BEND ± 1 ONE PLACE DECIMAL ± .05 TWO PLACE DECIMAL ± .015 THREE PLACE DECIMAL ± .005 BREAK AND DEBURR ALL EDGES .015 MAX			<table border="1"> <tr> <td>NAME</td> <td>DATE</td> <td>MATERIAL</td> </tr> <tr> <td>DRAWN</td> <td></td> <td></td> </tr> <tr> <td>CHECKED</td> <td></td> <td>HARDNESS</td> </tr> <tr> <td>ENG APPR.</td> <td></td> <td>WEIGHT</td> </tr> </table>		NAME	DATE	MATERIAL	DRAWN			CHECKED		HARDNESS	ENG APPR.		WEIGHT	SHEET 1 OF 1 SCALE: 1:1 FINISH	
NAME	DATE	MATERIAL																		
DRAWN																				
CHECKED		HARDNESS																		
ENG APPR.		WEIGHT																		
		SIZE B		DWG. NO. 1-17409		REV 1														

We appreciate hearing from you and receiving your feedback

We review your comments and ideas regularly and use them when planning changes. We promise to consider every suggestion.

Recommend changes for the next update to this manual. Send this information with your comments to Technical.Service@hypertherm.com:

- HyPrecision Predictive waterjet pump Operator Manual 810120 Revision 0
- Include page numbers, if applicable.
- Tell us the problem or make a suggestion.

Thank you for helping us improve our HyPrecision products.